

HI934

KARL FISCHER COULOMETRIC TITRATOR



**Dear
Customer,**

Thank you for choosing a Hanna Instruments® product.

Please read this instruction manual carefully before using this instrument. This manual will provide you with the necessary information for the correct use of this instrument, as well as a precise idea of its versatility.

If you need additional technical information, do not hesitate to e-mail us at tech@hannainst.com.

Visit www.hannainst.com for more information about Hanna Instruments and our products.



INTRODUCTION

The **HI934** is an automatic coulometric Karl Fischer titrator with high accuracy, great flexibility and repeatability. It is designed to perform titrations for a variety of sample types / matrices, allowing the user to obtain both good results and high-speed analysis.

The main attributes of the **HI934** titrator are:

- Small footprint, requires minimal bench space
- Casing made with strong, chemically resistant plastic
- Powerful built-in algorithms for termination criteria based on fixed mV endpoint or absolute / relative drift
- Sample analysis averaging
- Minimized water vapor entry with the Sealed Solvent System
- Balance interface for automatic weighing
- Support for 100 titration methods
- User-customizable reports
- Clearly displayed warning and error messages

This manual provides information regarding installation and functionality of the titrator and refined operation suggestions. Before using the titrator, it is recommended you become familiar with its various features and functionality.

This manual is divided into four parts.

PART 1: QUICK START GUIDE

Helps the user quickly setup and operate **HI934** Karl Fisher coulometric titrator. It covers basic connections, user interface and how to run a titration.

PART 2: INSTRUCTION MANUAL

Provides a comprehensive description of the operating principles, user interface, general options, methods, titration mode, optimization and maintenance.

PART 3: APPLICATIONS

Contains complete instructions for commonly-used analyses. Additional methods and method packs are available, contact your local Hanna Instruments office for more details.

PART 4: TITRATION THEORY

Outlines the principles of operation of the titrator. It covers the chemistry of titrations, titration types and result calculations.



TABLE OF CONTENTS

PART 1: QUICK START GUIDE

1. Safety Measures	1-2
2. Titrator Connections.....	1-3
2.1. Front View	1-3
2.2. Rear View	1-3
3. User Interface	1-4
3.1. Keypad.....	1-4
3.2. Display.....	1-4
4. Language.....	1-5
5. Contextual Help	1-5
6. Methods.....	1-5
6.1. Standard Methods.....	1-5
6.2. User-Defined Methods	1-5
7. Preparation	1-6
7.1. Setting Up the Titrator	1-6
7.2. Obtaining the Reagents	1-6
8. The First Titration	1-6
8.1. Method Selection.....	1-6
8.2. Setting Up Titration Report.....	1-6
8.3. Filling Titration Beaker with Reagent.....	1-6
8.4. Preparing the Reagent for Samples	1-6
8.5. Preparing & Introducing the Sample	1-7
8.6. Performing a Titration	1-7
8.7. Titration Screen	1-8
8.8. Titration Graph	1-8
8.9. Titration Termination.....	1-8
8.10. Results	1-9
8.11. Viewing the Last Titration Data	1-9
8.12. Printing the Titration Report	1-9
8.13. Saving Data to USB Storage Device	1-10
8.14. Titration Report	1-11

PART 2: INSTRUCTION MANUAL

1. Setup.....	2-2
1.1. Unpacking.....	2-2
1.2. Safety Measures.....	2-3
1.3. Technical Specifications.....	2-4
1.4. Installation	2-6
2. User Interface	2-12
2.1. Start Up	2-12
2.2. Keypad.....	2-12
2.3. Display.....	2-14
2.4. Menu Navigation.....	2-15
3. General Options	2-17
3.1. Save Files to USB Storage Device.....	2-17
3.2. Restore Files from USB Storage Device	2-18
3.3. Standby Mode.....	2-19
3.4. Standby Duration	2-19
3.5. Reagent Exchange Reminder	2-20



3.6. USB Link with PC	2-22
3.7. Setup Balance Interface	2-22
3.8. Stirrer	2-23
3.9. Printer Mode	2-24
3.10. Date and Time Setting	2-24
3.11. Display Settings	2-25
3.12. Beeper	2-26
3.13. Language	2-26
3.14. Calibration Check	2-27
3.15. Reset to Default Settings	2-28
3.16. Optimize Memory Space	2-28
3.17. Update Software	2-29
4. Titration Methods	2-30
4.1. Selecting Methods	2-30
4.2. Standard Methods	2-30
4.3. User Methods	2-32
4.4. Viewing / Modifying Method	2-33
4.5. Method Options	2-34
4.6. Printing	2-50
5. Titration Mode	2-51
5.1. Idle Mode	2-51
5.2. Pre-Titration	2-52
5.3. Drift Analysis (Automatic Determination Entry Only)	2-52
5.4. Standby	2-53
5.5. Sample Analysis	2-54
6. Auxiliary Functions	2-59
6.1. Air Pump	2-59
6.2. Stirrer	2-60
6.3. Results	2-60
7. Maintenance & Peripherals	2-64
7.1. Generator Electrode Maintenance	2-64
7.2. Detector Electrode Maintenance	2-64
7.3. Reagent Adapter Holder Maintenance	2-65
7.4. Reagent Exchange Adapter Maintenance	2-65
7.5. Peripherals	2-65
8. Method Optimization	2-68
8.1. Titration Settings	2-68
8.2. The Sample	2-71
8.3. Karl Fischer Reagent System	2-74
9. Accessories	2-75
9.1. Analyte for Cells with and without Diaphragm	2-75
9.2. Analyte for Cells with Diaphragm	2-75
9.3. Analyte for Cells without Diaphragm	2-75
9.4. Catholyte for Cells with Diaphragm	2-75
9.5. Water Standards	2-75
9.6. Titrator Components	2-76

PART 3: APPLICATIONS

HI9001EN Titrator Validation with 1.0 mg/g Water Standard	3-2
HI9301EN Moisture Determination in Solvent	3-4
HI9901EN Bromine Index of Aromatic Hydrocarbons	3-6



PART 4: TITRATION THEORY

1. Titration Theory.....	4-2
1.1. Introduction to Titrations.....	4-2
1.2. Uses of Titrations.....	4-2
1.3. Advantages & Disadvantages of Titrations.....	4-2
2. Types of Titrations.....	4-3
2.1. Titrations According to the Measurement Method.....	4-3
2.2. Titrations According to the Reaction Type.....	4-4
2.3. Titrations According to the Titration Sequence.....	4-11
3. Titration Procedure.....	4-12
3.1. Manual Titration.....	4-12
3.2. Automatic Titration.....	4-13
4. Titration Results.....	4-14
4.1. Accuracy.....	4-14
4.2. Repeatability.....	4-14
4.3. Sources of Error.....	4-14
5. Calculations.....	4-16
5.1. Equations Used in Volumetric Karl Fischer Titrations.....	4-16
5.2. Equations Used in Titrations.....	4-18
6. Glossary.....	4-21

PART 1:

QUICK START GUIDE



1. SAFETY MEASURES

The following safety measures must be followed:

- 1) Never connect or disconnect the air pump and magnetic stirrer assembly or other peripheral with the titrator turned on.
- 2) Verify that the reagent and the attached tubing are assembled correctly.
- 3) Always check that the reagent, waste bottles and the titration beaker are properly assembled.
- 4) Always wipe up spills and splashes immediately.
- 5) Avoid the following environmental working conditions:
 - Severe vibrations
 - Direct sunlight
 - Atmospheric relative humidity above 80 % non-condensing
 - Environment temperatures below 10 °C and above 40 °C
 - Explosion hazards
 - Near heating or cooling sources
- 6) Have the titrator serviced by qualified service personnel only.
- 7) Avoid inhalation of reagent vapors. Avoid contact with chemicals.

2. TITRATOR CONNECTIONS

2.1. FRONT VIEW

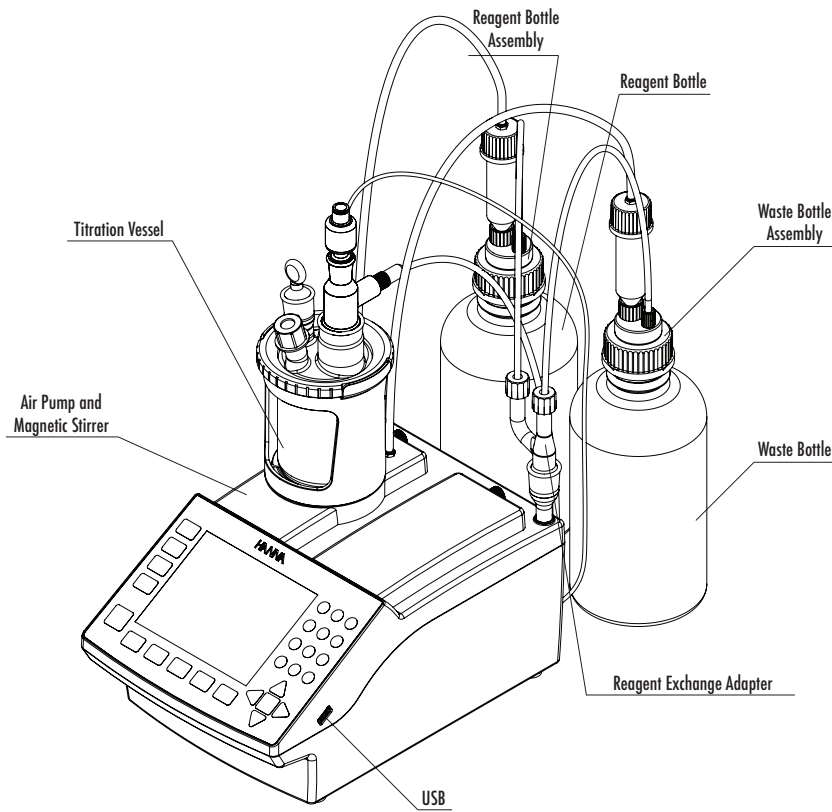

2.2. REAR VIEW

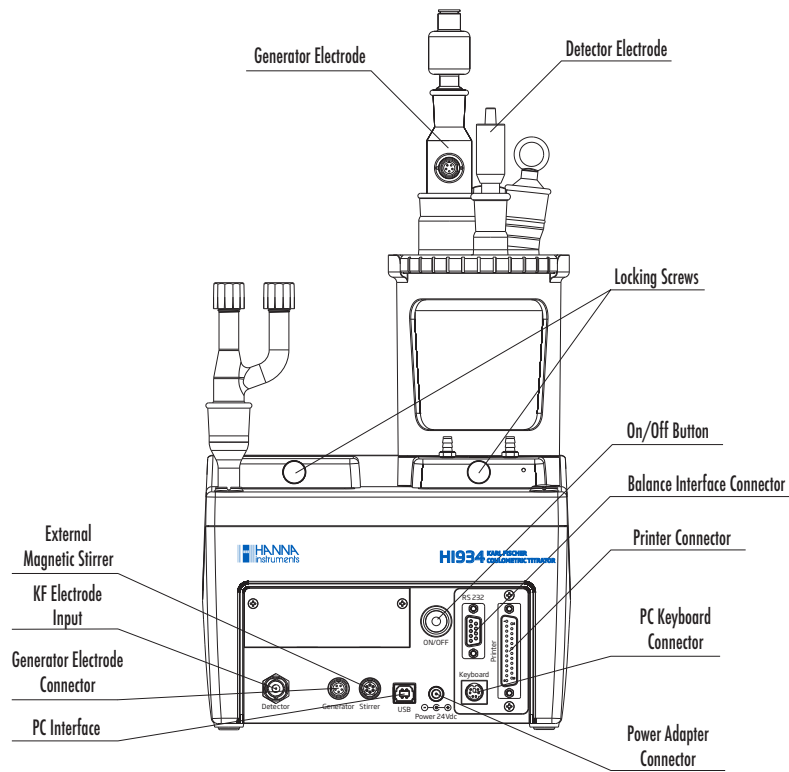

3. USER INTERFACE

3.1. KEYPAD

The titrator's keypad has 27 keys grouped in five categories.

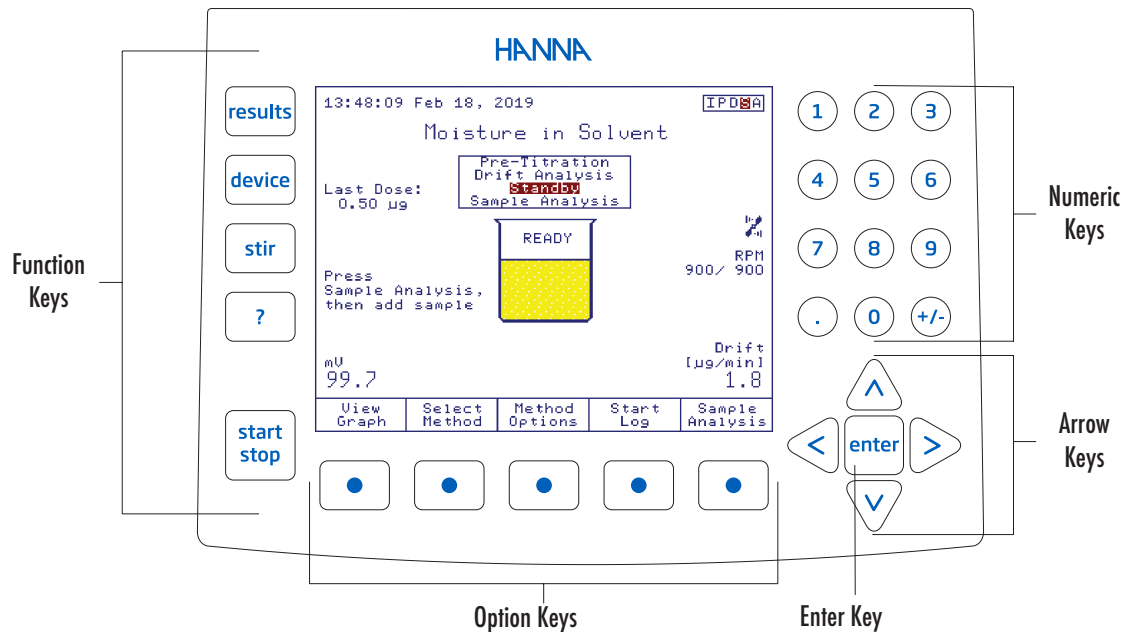

3.2. DISPLAY

The titrator has a 5.7" graphical backlit color display. The **Standby** screen is shown below with short explanations.

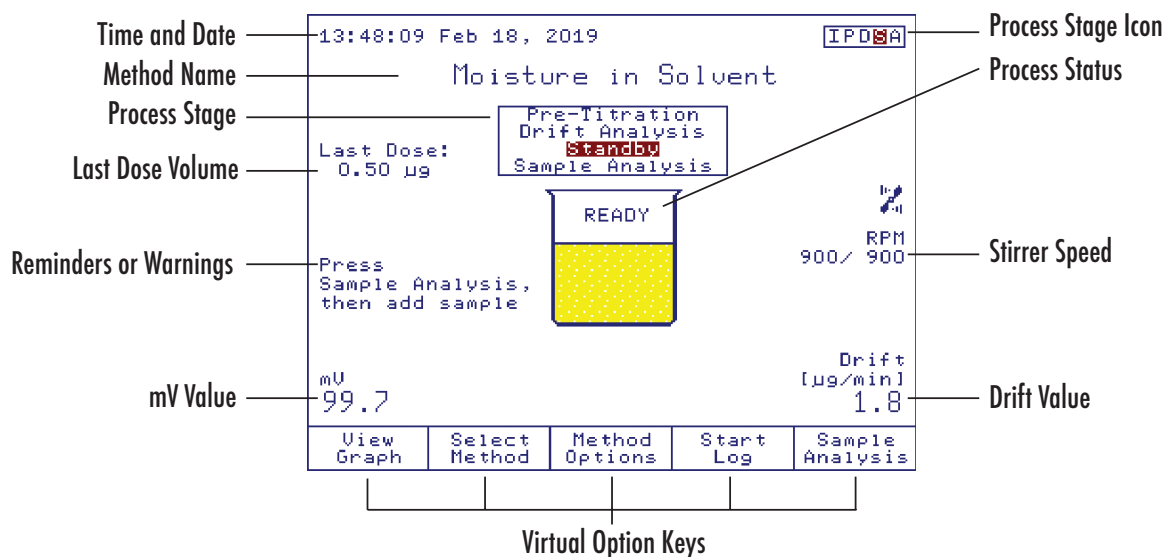

The user interface contains several screens. In each screen, many information fields are present at the same time. The information is displayed in an easy-to-read manner.

Virtual option keys describe the function performed when the corresponding soft key is pressed.

4. LANGUAGE

To change the language, press **General Options** from the main screen. Highlight *Language* option. Using the \triangle and ∇ keys, select the language from the options listed in the **Set Language** screen and press **Select**. Restart the titrator in order to apply the new language setting.

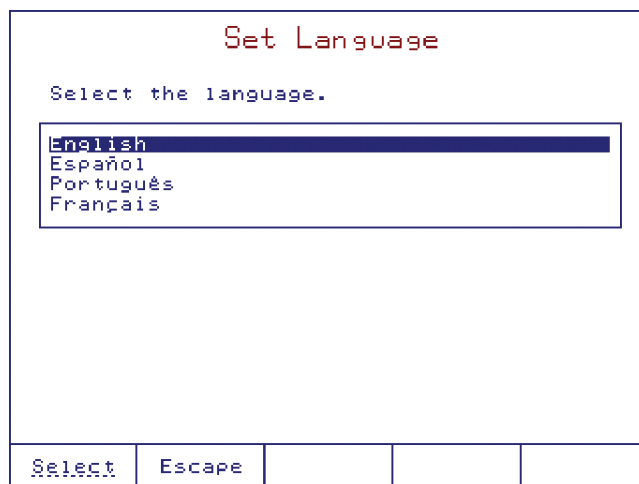

5. CONTEXTUAL HELP

The contextual help can be accessed at any time by pressing **?** key, it provides useful information about the current screen.

6. METHODS

The **HI934** Karl Fischer titrator can store up to 100 methods (standard and user defined).

6.1. STANDARD METHODS

Each titrator is supplied with a customized package of standard methods. Standard method packs are developed at Hanna Instruments to meet analysis requirements of specific industries.

6.2. USER-DEFINED METHODS

User-defined methods allow the user to create and save their own methods. Each new method is based on an existing method which is altered to suit a specific application.

7. PREPARATION

7.1. SETTING UP THE TITRATOR

Verify that:

- All of the titrator assemblies have been properly installed (see [1. SETUP](#) section).
- The titration vessel is properly sealed against atmospheric moisture (the fittings and tubes are correctly mounted).
- The desiccant has been properly dried.

7.2. OBTAINING THE REAGENTS





- The reagents have to be suitable to the analysis requirements (see [9. ACCESSORIES](#) section for list of preferred reagents).

8. THE FIRST TITRATION

8.1. METHOD SELECTION

For this analysis we will use the **HI9301EN Moisture in Solvent** standard method.







To select this method:

- Press  from the **Idle** screen. Use the  and  keys to highlight *HI9301EN Moisture in Solvent* method.
- Press .

The method's name will be displayed on the top line of the **Idle** screen.





8.2. SETTING UP TITRATION REPORT

Users can select the information that is stored for each titration.

- From the main screen, press  key and the **Data Parameters** screen will be displayed.
- Highlight *Setup Titration Report* option and press .
- Mark the fields to be included with the * symbol using the  and  keys, and press  to toggle the selection.
- Press  and then press  to return to the main screen.

8.3. FILLING TITRATION BEAKER WITH REAGENT

The titration vessel must be filled with solvent up to the minimum (MIN) mark (about 75 mL):

- From the **Idle** screen, press .
- Press .
- Wait until the beaker is filled up to the minimum (MIN) mark with solvent.
- Stop the air pump by pressing .
- Press  then enter the approximate amount of solvent in the beaker.
- Press  to confirm.

8.4. PREPARING THE REAGENT FOR SAMPLES

Before beginning a titration, residual moisture inside the titration vessel and solvent must be reacted.

- From the **Idle** screen, press  key. The titrator will enter **Pre-Titration** mode and begin generating iodine in the titration vessel.
- Once all residual moisture has been reacted (endpoint potential is reached), the titrator will enter **Drift Analysis** mode (Automatic Drift Entry only). The titrator calculates the rate of atmospheric moisture seeping into the titration beaker for the next minute and displays the result in the lower right corner of the display.

- If the Drift Rate is stable and the endpoint potential is maintained, the titrator will enter **Standby** mode. The titrator continues to maintain the endpoint potential and update the background drift rate.

Note: New (or cleaned) detector electrodes have low electrical resistance due to a lack of platinum-iodine complexes on the electrode surface. This may cause initial mV readings to be low and prevent proper pre-titration of the reagent. The endpoint value should be 200 to 250 mV below the mV value of “wet” reagent for proper pre-titration to occur. If necessary, adjust the endpoint and / or imposed current in Method Options to facilitate proper pre-titration. The platinum-iodine complex should form after several titrations and raise the mV readings.

8.5. PREPARING & INTRODUCING THE SAMPLE

SAMPLE MASS PREPARATION

Measuring the sample size by mass using an analytical balance will give the most reproducible results.

Samples will be injected through the septum.



Weigh the syringe before and after injection in order to increase precision (back-weighing technique).

SAMPLE VOLUME PREPARATION

Liquid samples can be added by volume.

Samples should be added using a precision syringe and needle.

8.6. PERFORMING A TITRATION

- From the main screen, press  to analyze a sample. You will be prompted to enter the analyte size. Add a prepared sample to the titration vessel. Enter the analyte size and press . The titrator will start the analysis according to the selected method.
- At the end of the titration, the message “Titration Completed” will appear on the titration status, together with the final concentration of the moisture in the sample, the endpoint volume and other relevant information. The titrator will enter **Standby** mode automatically.

Sample Analysis Result		IPD
1.1629 mg/g		
Titration Completed		
Analysis Duration:	04:32 [mm:ss]	
Titrated Water:	292.8 µg	
Drift Value:	3.9 µg/min	
Sample Size:	0.2366 g	
Report ID:	KF_00025	
Escape	View Report	Average Results

8.7. TITRATION SCREEN

During a titration, the following screen is displayed:

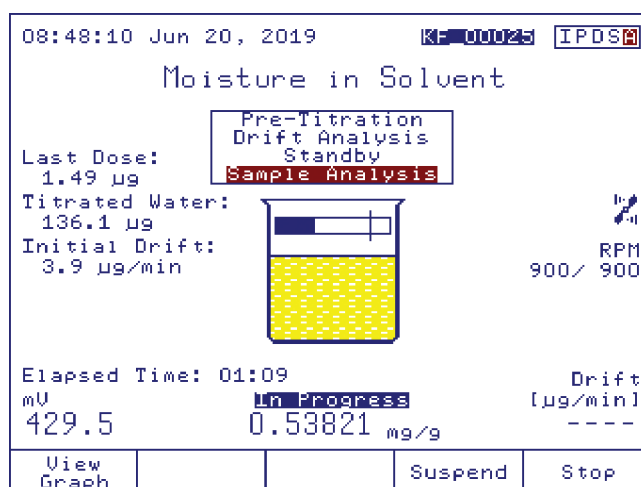

8.8. TITRATION GRAPH

Press **View Graph** to display the real time titration graph.

The curve displayed is a plot of Electrode Potential vs. Titrated Water.

A dashed horizontal line represents the selected endpoint potential.

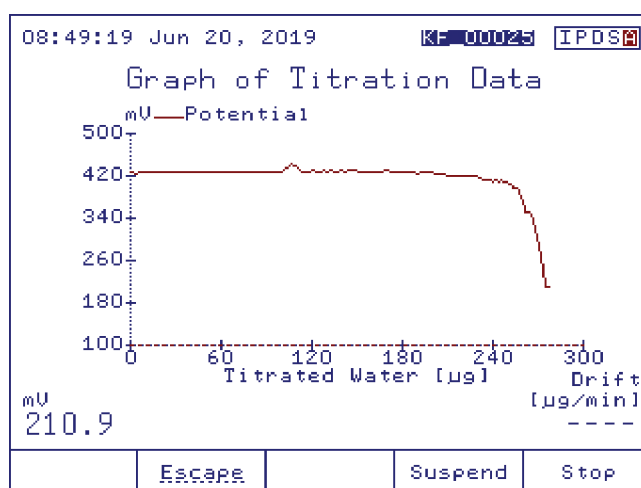

Note: For fresh solvents, the first few titration graphs may look a little noisy. After several titrations, the reaction speed and graph should improve.

8.9. TITRATION TERMINATION

The titration is terminated when the conditions of the Termination Criteria have been met.

The default Termination Criterion is a mV value, in which the titration is terminated after the mV value remains below the endpoint potential for the selected stability time.

When the titration has ended, the titrator will display the final concentration of the moisture together with the basic titration information.

To view the custom report or titration graph, press **View Report**.

To view statistics of multiple analyses, press **Average Results**.

When done, press **Escape** to return to standby mode (if active).

8.10. RESULTS

The results obtained from a titration are stored in a report file that can be viewed, printed, transferred to a USB storage device or a PC.

Review Result			
KF_00025.RPT			
HI934 - Titration Report			
Method Name:	Moisture in Solvent		
Time & Date:	08:47 Jun 20, 2019		
Titration ID:	KF_00025		
Nr	TitrWater[ug]	mV	Time
0	0.0	426.1	00:00:00
1	0.0	427.3	00:00:01
2	1.5	426.4	00:00:02
3	3.0	425.3	00:00:03
4	4.5	425.3	00:00:04
5	6.0	426.4	00:00:05
6	7.4	426.7	00:00:06

View Graph	ESCAPE	Print Report	Page Up	Page Down
------------	--------	--------------	---------	-----------

8.11. VIEWING THE LAST TITRATION DATA

- From the main screen, press **results** key. The **Data Parameters** screen will be displayed.
- From the **Data Parameters** screen highlight *Review Last Report* option and press **Select**. The **Review Result** screen will be displayed.
- Use the **Page Up** and **Page Down** keys to display information related to the last titration performed.

8.12. PRINTING THE TITRATION REPORT

Connect a DOS / Windows-compatible parallel printer directly to the DB-25 pin connector located on the back of the titrator.







Note: Prior to connecting the printer, ensure that the titrator and the printer have been turned off.

Printing out the report:





- From the **Review Report** screen, press **Print Report**.
- During the information transfer to the printer, the message "Printing" will be displayed on the screen.
- Press **Escape** to return to the **Data Parameters** screen.
- Press **Escape** again to return to the main screen.

8.13. SAVING DATA TO USB STORAGE DEVICE

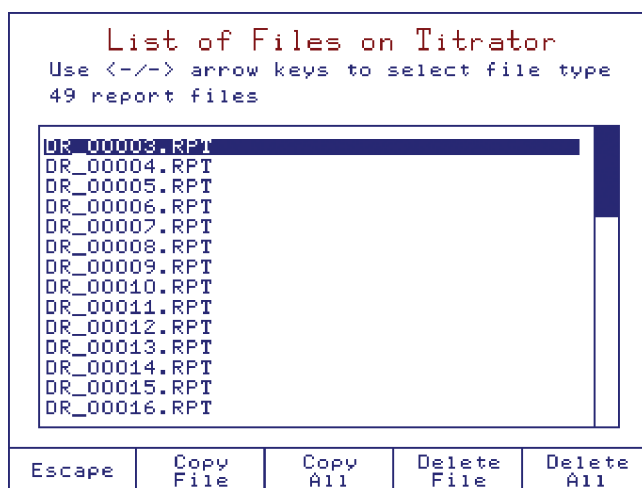
This feature allows the results of titrations or drift logging sessions to be saved to USB storage device.

- From the main screen, press  the **General Options** screen will be displayed.
- Highlight *Save Files to USB Storage Device* option using the  and  keys.
- Insert the USB storage device into the USB socket.
- Press , the **List of Files on Titrator** screen will be displayed.
- Use the  and  keys to select the report files.



- Press  to transfer all available reports to the USB storage device, or highlight the name of the report file to be transferred and press .
- Transferring a report file will automatically transfer the corresponding log file and titration graph (*.BMP file if applicable).
- Press  to return to the **General Options** screen.
- Press  again to return to the main screen.

Note: The USB Storage Device has to be formatted FAT or FAT32.

8.14. TITRATION REPORT

While scrolling using  and  the fields below can be seen on the titrator display or printed. The same information is available on the saved report file.

HI934 - Titration Report

```

Method Name:                TEST 1mg/g
Time & Date:                14:36 Feb 14, 2019
Titration ID:              KF_00055
Company Name:
Operator Name:
Electrode Name:
Field 1:
Field 2:
Field 3:
Titrator Software Version:  v1.00
Base Board Software Version: v1.00
Stirrer Software Version:   v1.00
Titrator Serial Number:    101490001111
Analog Board Serial Number: 201510004111
Stirrer Serial Number:     000000000000
Analog Calibration Date:   Dec 20, 2018
  
```

Method Parameters

```

Name:                       Moisture in Solvent
Method Revision:            1.0
Type:                       KF Coulometric
Pre-Analysis Stir Time:    5 Sec
Stirring Speed:            900 RPM
Stirbar Type:              Medium
Drift Entry:               Automatic
Reagent:                   General Purpose
Sample Parameters:
  Sample Determ.:          Normal
  Sample Name:             DefaultSample
  Sample Type:             Mass
  Sample Size:             0.3055 g
Control Parameters:
  Titration Speed:         Auto
  Imposed Current:         2 µA
  End Point Value:         100.0 mV
  Generator Current Mode:  Auto
  Signal Averaging:       2 Readings
Termination Parameters:
  Maximum Duration:        1200 sec
  Maximum Water Titrated:  10.0 mg
  Term. Criterion:         Relative Drift
  Relative Drift:          3.0 µg/min
Result Unit:                ppm
  
```

Nr	TitrWater[μ g]	mV	Time
0	0.0	467.4	00:00:00
1	0.0	469.0	00:00:01
2	9.9	467.8	00:00:03
3	19.8	466.2	00:00:04
4	29.8	465.8	00:00:05
5	39.7	465.8	00:00:06
6	49.6	466.2	00:00:07
7	59.5	466.3	00:00:08
8	74.4	466.1	00:00:09
9	89.4	465.8	00:00:10
10	104.3	466.3	00:00:11
11	119.2	466.8	00:00:12
12	134.1	466.8	00:00:13
13	149.1	467.8	00:00:14
14	164.0	469.3	00:00:15
15	186.4	469.1	00:00:16
16	208.9	468.5	00:00:17
17	231.3	468.4	00:00:18
18	253.8	468.4	00:00:19
19	276.3	465.6	00:00:20
20	298.7	472.7	00:00:21
21	321.2	478.0	00:00:22
22	354.9	478.2	00:00:23
23	388.5	477.1	00:00:25
24	422.2	468.8	00:00:26
25	455.9	461.8	00:00:27
26	465.8	482.8	00:00:28
27	475.8	487.3	00:00:29
28	485.7	464.6	00:00:30
29	495.6	463.6	00:00:31
30	505.5	464.9	00:00:32
31	515.5	464.6	00:00:33
32	525.4	464.5	00:00:34
33	535.3	464.5	00:00:35
34	545.2	464.0	00:00:36
35	555.1	463.6	00:00:37
36	565.1	463.5	00:00:38
37	575.0	464.3	00:00:39
38	584.9	461.9	00:00:40
39	594.8	459.6	00:00:41
40	604.8	456.7	00:00:42
41	614.7	457.7	00:00:43
42	624.6	461.8	00:00:44
43	634.5	461.1	00:00:45
44	644.5	460.0	00:00:47
45	654.4	460.0	00:00:48
46	664.3	457.4	00:00:49
47	674.2	454.8	00:00:50
48	684.1	452.1	00:00:51
49	694.1	452.1	00:00:52
50	704.0	449.8	00:00:53
51	713.9	447.6	00:00:54
52	723.8	447.6	00:00:55
53	733.8	447.3	00:00:56
54	743.7	441.1	00:00:57
55	753.6	434.2	00:00:58
56	763.5	429.7	00:00:59
57	773.4	428.7	00:01:00
58	783.4	426.9	00:01:01

59	793.3	419.9	00:01:02
60	803.2	415.5	00:01:03
61	813.1	399.4	00:01:04
62	823.1	373.8	00:01:05
63	833.0	356.4	00:01:06
64	842.9	345.9	00:01:07
65	852.8	330.7	00:01:09
66	862.8	300.6	00:01:10
67	872.7	266.8	00:01:11
68	882.6	237.4	00:01:12
69	892.5	202.0	00:01:13
70	902.4	159.0	00:01:14
71	903.9	116.6	00:01:15
72	905.4	88.9	00:01:16
73	905.4	84.1	00:01:17
74	905.4	92.0	00:01:18
75	905.4	108.4	00:01:19
76	906.9	139.0	00:01:20
77	908.4	181.2	00:01:21
78	909.9	224.5	00:01:22
79	911.4	259.4	00:01:23
80	912.9	288.0	00:01:24
81	914.4	308.3	00:01:25
82	924.3	321.9	00:01:26
83	934.2	331.9	00:01:27
84	944.1	293.3	00:01:29
85	954.0	175.2	00:01:30
86	955.5	79.5	00:01:31
87	955.5	54.4	00:01:32
88	955.5	50.3	00:01:33
89	955.5	54.4	00:01:34
90	955.5	58.0	00:01:35
91	955.5	59.6	00:01:36
92	955.5	61.0	00:01:37
93	955.5	62.1	00:01:38
94	955.5	63.7	00:01:40
95	955.5	65.1	00:01:41
96	955.5	66.4	00:01:42
97	955.5	67.1	00:01:43
98	955.5	67.7	00:01:44
99	955.5	68.0	00:01:45
100	955.5	69.2	00:01:46
101	955.5	70.3	00:01:47
102	955.5	70.3	00:01:48
103	955.5	70.5	00:01:49
104	955.5	71.8	00:01:51
105	955.5	72.7	00:01:52
106	955.5	72.0	00:01:53
107	955.5	72.6	00:01:54
108	955.5	73.3	00:01:55
109	955.5	73.6	00:01:56
110	955.5	74.2	00:01:57
111	955.5	73.7	00:01:58
112	955.5	73.6	00:01:59
113	955.5	73.9	00:02:00
114	955.5	73.5	00:02:02
115	955.5	73.9	00:02:03
116	955.5	74.3	00:02:04
117	955.5	74.4	00:02:05
118	955.5	74.3	00:02:06

119	955.5	74.5	00:02:07
120	955.5	75.7	00:02:08
121	955.5	75.7	00:02:09
122	955.5	75.2	00:02:10
123	955.5	76.2	00:02:11
124	955.5	76.8	00:02:13

Titration Results

Method Name: Moisture in Solvent
Time & Date: 14:36 Feb 14, 2019
Sample Size: 0.3066 g
Drift Value: 5.2 µg/min
Titrated Water 955.53 µg
Result: 3.1105 mg/g
Titration Duration: 03:12 [mm:ss]
Generator Electrode Type: HI 900512
Titration went to Completion
Operator Name:

Analyst Signature: _____

PART 2:

INSTRUCTION MANUAL



1. SETUP

1.1. UNPACKING

Remove the titrator and accessories from the packaging and examine it carefully to make sure that no damage has occurred during shipping. If any of the items are damaged or missing, please contact your sales representative or your nearest Hanna Instruments service center.

Each **HI934** titrator is supplied with:

ITEM	QUANTITY
Titrator	1 pc
Air Pump and Magnetic Stirrer Assembly.....	1 pc
Titration Vessel Assembly.....	1 pc
• Titration Vessel	
• Glass Stopper	
• Sample Port Cap and Septum	
• Stir Bar	
• Desiccant	
• Desiccant Cartridge	
• Fittings	
• O-rings	
Beaker Support	1 pc
Pump Locking Screws with Plastic Head.....	2 pcs
Reagent Bottle Assembly.....	1 pc
• Bottle Cap	
• Desiccant	
• Desiccant Cartridge	
• Fittings	
• O-rings	
• Tubes (Silicone and PTFE Tubing)	
Waste Bottle Assembly.....	1 pc
• Bottle Cap	
• Desiccant	
• Desiccant Cartridge	
• Fittings	
• O-rings	
• Tubes (Silicone and PTFE Tubing)	
Detector Electrode.....	1 pc
Calibration Key.....	1 pc
Reagent Exchange Adapter.....	1 pc
Reagent Adapter Holder.....	1 pc
Glass Joint Grease.....	1 pc
Karl Fisher Generator Electrode with Removable Cable.....	1 pc
Power Adapter.....	1 pc

USB Cable	1 pc
Instruction Manual.....	1 pc
USB Storage Device	1 pc
Quality Certificate	1 pc

See **9. ACCESSORIES** section for component pictures.

Note: *Save all packing materials until you are sure that the instrument functions correctly. Any damaged or defective items must be returned in their original packing materials together with the supplied accessories.*

1.2. SAFETY MEASURES

The following safety measures must be followed:

- 1) Never connect or disconnect the air pump and magnetic stirrer assembly with the titrator turned on.
- 2) Verify that the reagent bottle, waste bottle and titration vessel are properly assembled.
- 3) Always check that the reagent, waste bottles and the titration beaker are properly assembled.
- 4) Always wipe up spills and splashes immediately.
- 5) Avoid the following environmental working conditions:
 - Severe vibrations
 - Direct sunlight
 - Atmospheric relative humidity above 80 % non-condensing
 - Environment temperatures below 10 °C and above 40 °C
 - Explosion hazards
 - Near heating or cooling sources
- 6) Have the titrator serviced only by qualified service personnel.

1.3. TECHNICAL SPECIFICATIONS

Measurement	Range	1 ppm to 5%
	Resolution	0.1 ppm
	Result Units	%, ppm, mg/g, $\mu\text{g/g}$, mg, μg , mg/mL, $\mu\text{g/mL}$, ppt, mgBr/100g, gBr/100g, mgBr, gBr
	Sample Type	Liquid or Solid
Determination	Pre-Titration Conditioning	Automatic
	Background Drift Correction	Automatic or user selectable value
	Endpoint Criteria	Fixed mV persistence, Relative drift stop or Absolute drift stop
	Dosing	Dynamic with 3 speed settings
	Result Statistics	Mean, standard deviation
Titration Vessel	Type	Borosilicate glass with standard taper glass joint connections
	Operating Volume	100 to 200 mL
	Septum	Silicone rubber
	Septum Cap Thread	GL-18
	Reagent Port	Standard taper 19
Detector Electrode	Type	Dual platinum pin, polarization electrode
	Connection	BNC
	Glass Connection	Standard Taper 14/20
	Polarization Current	1, 2, 5, 10 μA
	Voltage Range	2 to 1100 mV
	Voltage Resolution	0.1 mV
	Accuracy	$\pm 0.1\%$
Generator Electrode	Type	Diaphragm or Diaphragm-less
	Electrode Type Detection	Automatic
	Electrical Connection	5-pin connector with detachable cable
	Glass Connection	Standard taper 29/12
	Maximum Current	400 mA
	Current Control	Automatic or Fixed (400 mA)
Stirrer	Type	Magnetic, electronic regulated
	Speed	200 to 2000 RPM
	Resolution	100 RPM
	External Stirrer	4-pin mini DIN connection allows for the control of an external stirring apparatus
Reagent Handling System	Type	Sealed system with integrated diaphragm air pump
	Desiccant Type	Molecular sieves
	Bottle Thread Type	GL-45
	Glass Connection	Standard taper 19 (using supplied adapter)
	Reagent/Waste Tubing	PTFE

Peripheral Devices	PC Connection	1 x USB Standard B
	USB Flash Drive	1 x USB Standard A
	Analytical Balance	1 x DB-9 Socket
	Printer	1 x DB-25 Socket
	External PC Keyboard	1 x 6-pin Mini DIN
Additional Specifications	Display	5.7" graphical color display with backlight
	Languages	English, Portuguese, Spanish, French
	Power Supply	100-240 Vac, 50/60 Hz
	Power Draw	0.5 Amps
	Enclosure Material	ABS, PC and Stainless Steel
	Keypad	Polyester
	Dimensions	315 x 205 x 375 mm (12.4 x 8.1 x 14.8 ")
	Weight	approx. 4.3 kg (9.5 lbs.) with 1 stirrer/air pump and sensors
	Operating Environment	10 to 40 °C (50 to 104 °F); up to 80 % RH
Storage Environment	-20 to 70 °C (-4 to 158 °F); up to 95 % RH	

1.4. INSTALLATION

1.4.1. TITRATOR RIGHT VIEW

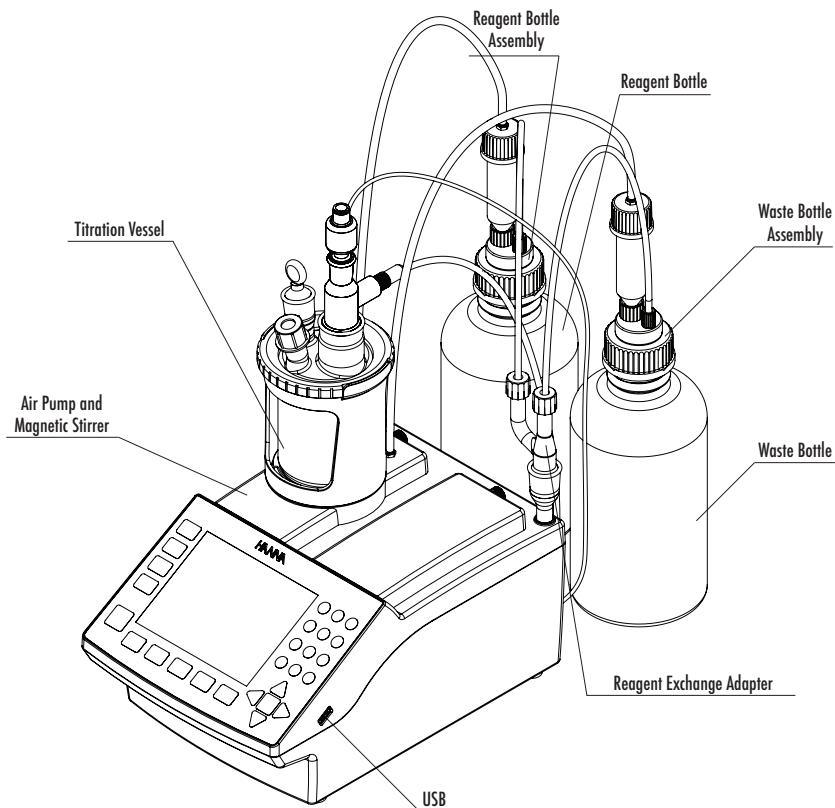

1.4.2. TITRATOR REAR VIEW

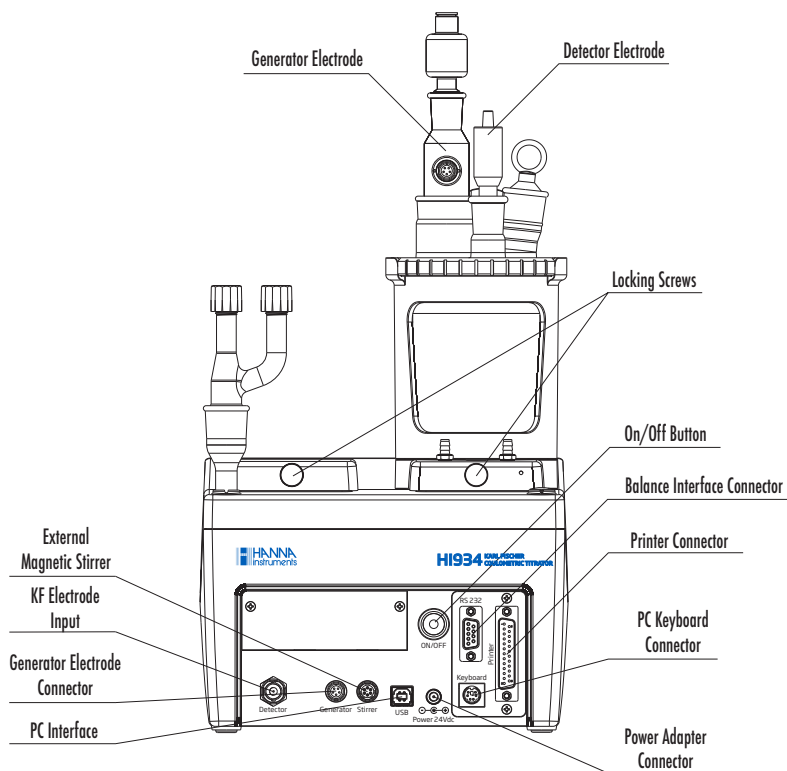

1.4.3. TITRATOR ASSEMBLY

Warning! Assembly operations must be completed before connecting the titrator to the power supply!

1.4.3.1. CONNECTING THE AIR PUMP & REAGENT HOLDER

To connect the air pump and magnetic stirrer, follow these steps:

- Retrieve the air pump cable from inside the left bay.
- Connect the cable to the air pump as shown below (A). The connector is located on the bottom of the air pump assembly.
- Lower the pump into the titrator (B), then slide it towards the front of the titrator case until it is firmly latched.
- Secure the pump with the locking screw (C).
- Insert the reagent adapter holder in the dedicated place (D).

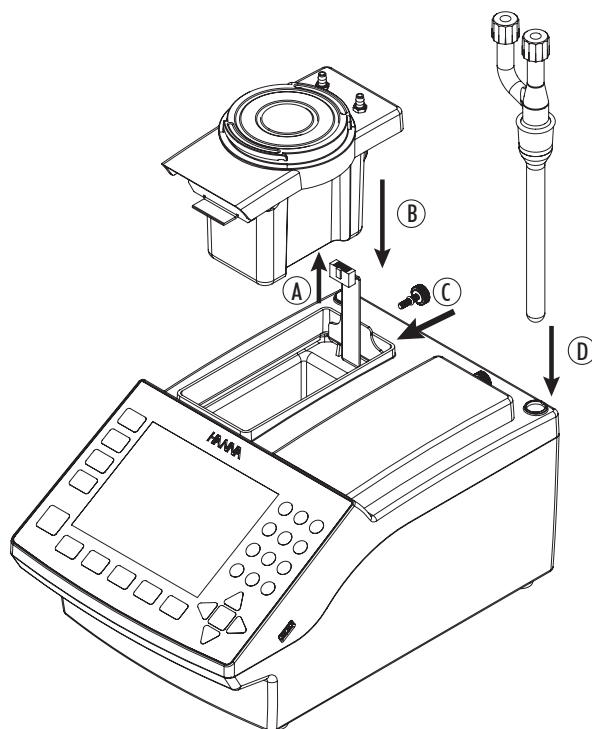

1.4.3.2. TITRATION VESSEL

The titration takes place in a sealed vessel. The titration vessel can also be referred to as a reaction vessel, titration cell or reaction cell.

The primary design features of the **HI934** titration vessel include the following:

- Durability, easy to use, clean and maintain.
- All glass cells are manufactured with ground-glass joints for ultra-low water vapor permeability and high chemical resistivity to Karl Fischer reagents.
- A sample port with open-top screw cap for easy septum replacement.
- A desiccant cartridge containing molecular sieves to dry the ambient air which enters the cell as reagent and samples are added or removed from the titration vessel.
- Electrode port for generators with and without diaphragm.

To attach the titration vessel follow the steps below:

- Align the vessel support (D) with the base plate and attach by rotating clockwise.
- Insert the support adapter (C) onto the vessel support (D) while aligning the notches. If the o-ring (B) is not installed, insert it into the inner groove of the support adapter (C).
- Lower titration vessel into the vessel support (D) by gently pushing it through the support adapter (C).

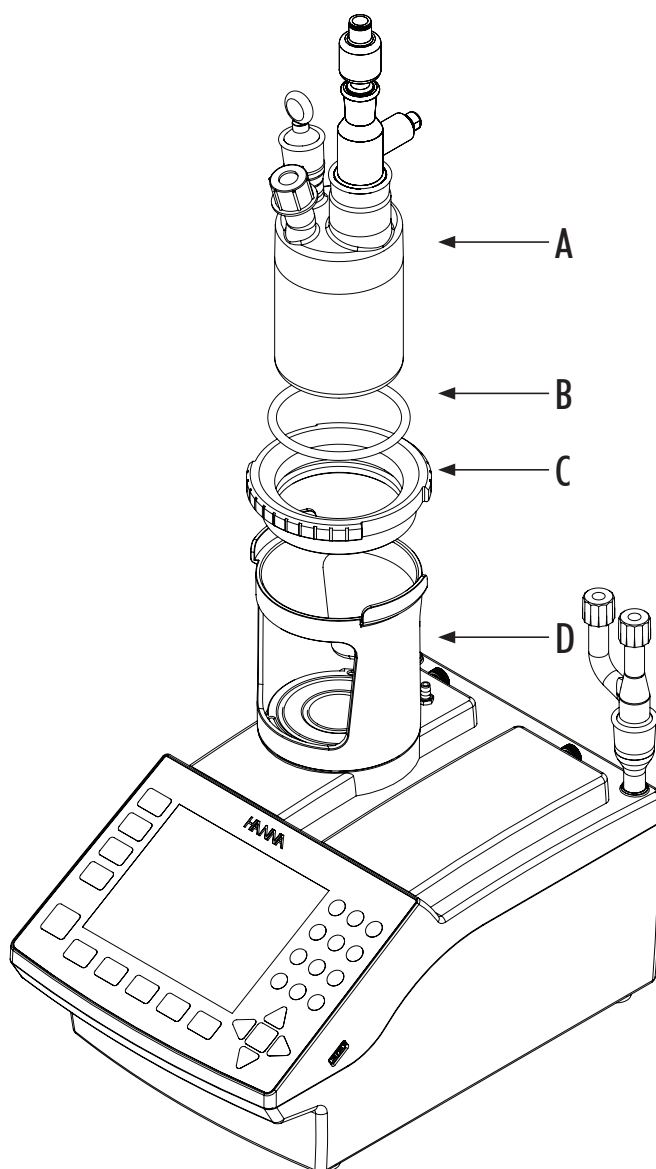

1.4.3.3. BEAKER TOP

Warning! Do not overtighten fittings! This may cause permanent damage to o-rings and beaker top!

To assemble the beaker top follow the steps below:

- 1) Insert the Karl Fisher detector electrode (F) into the dedicated ground-glass port.
- 2) Insert the Karl Fisher generator electrode (D) into the dedicated ground-glass port.
- 3) Attach the desiccant cartridge (E) to the top of the generator electrode (D).
- 4) Place the glass stopper (G) into the dedicated ground-glass port.
- 5) Place the silicone rubber septum (B) into the bottom of the GL-18 cap (C). Secure the cap to the titration vessel.

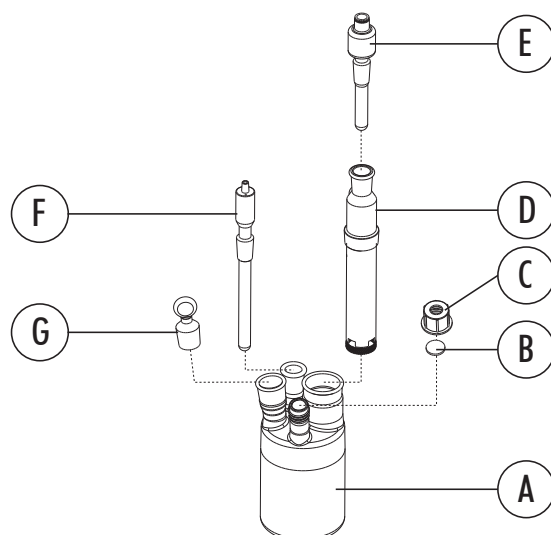

1.4.3.3.1. KARL FISCHER DETECTOR ELECTRODE

The Karl Fischer detector electrode (F) consists of two parallel, platinum pins sealed into a 10 mm diameter glass body. Two steel pins connect the platinum elements to a standard BNC connector, which allows for easy attachment to the **HI934**.

1.4.3.3.2. KARL FISCHER GENERATOR ELECTRODE

The Karl Fischer generator electrode (D) consists of two platinum electrodes (anode and cathode) on a glass body. The anode and cathode may be separated by a diaphragm that is built into the body of the generator. The **HI934** can be used with diaphragm and diaphragm-less generators.

1.4.3.3.3. DESICCANT CARTRIDGE

The desiccant cartridge (E) provides a dry path for pressure equalization between the ambient air and the inside of the titration vessel.

1.4.3.3.4. REAGENT EXCHANGE PORT

The **HI934** titration vessel can be connected to the reagent and waste bottles using the reagent exchange port and the supplied adapter. The reagent exchange adapter may remain connected to the titration vessel during operation if a lower drift rate is not necessary.

1.4.3.3.5. SAMPLE PORT

The sample port consists of a silicone rubber septum (B) secured in place with an open-top GL-18 cap (C). This allows liquid samples to be added to the titration vessel with a syringe and needle while sealing the vessel from atmospheric moisture. The rubber septum can be easily replaced as needed by removing the threaded cap.

1.4.4. ELECTRICAL CONNECTIONS

- Connect the Karl Fisher electrode detector to the BNC connector (A).
- Connect the Karl Fisher generator electrode to the 5-pin connector (B) using the supplied cable.
- Connect the power adapter cable to the power input connector (E).

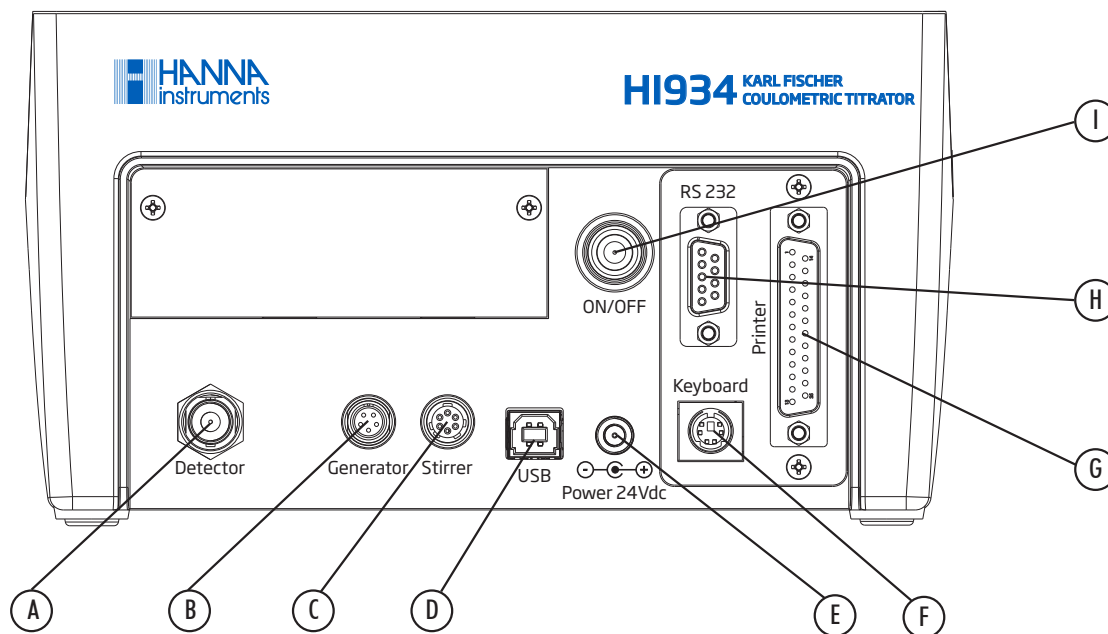

	Function	Type of Connector
A	Detector Electrode	BNC socket
B	Generator Electrode	5-pin Connector
C	External Magnetic Stirrer	6-pin Connector
D	USB Interface	USB Standard B
E	Power Input Connector (24VDC)	DC Power Jack Connector
F	External PC Keyboard	6-pin Mini Din (Standard PS2)
G	Printer	DB-25 Socket
H	RS 232 Interface (Balance Interface)	DB-9 Socket
I	Power Switch	

1.4.5. REAGENT, WASTE BOTTLE ASSEMBLY

The bottle top assemblies are equipped with desiccant cartridges containing molecular sieves, which ensures that the air passing through the reagent handling system has been dried.

Note: *Molecular sieves have a limited capacity to absorb moisture and are typically exhausted after 3 to 5 weeks. Molecular sieves can be regenerated at 300 °C.*

The bottle tops are constructed of PTFE and have been designed to accommodate reagent bottles with GL-45 type threaded tops.

The waste and reagent bottle top assemblies include blue PTFE tubing for the handling of liquid Karl Fischer reagent and a clear flexible silicone based tubing for use with the air pump.

Caution: *Most Karl Fischer reagents give off harmful vapors. Consult manufacturer's MSDS for safe handling guidelines.*

To assemble the reagent or waste bottle, follow the steps below:

- Insert a PTFE top (J) into a GL-45 cap (E).
- Screw on the desiccant cap with screw hose barb (A).
- Insert a desiccant cartridge (B) with hose-barbed cap (A) through a 10 mm fitting (F) and 10 mm o-ring (G).
- Insert and screw the desiccant fitting into the corresponding hole. Fasten the desiccant cartridge assembly to PTFE top (J) with 10 mm fitting (F).
- Insert the reagent / waste tube (D) in the 5 mm fitting (H) and attach the o-ring (I).
- Insert and screw the tube fitting into the corresponding hole in the cap.
- Screw GL-45 (E) cap with full assembly onto reagent or waste bottle.
- Add the air tube (C) to the desiccant cap (A) and connect it to the corresponding position on the air pump. The "Fill" position connects to the reagent bottle assembly. The "Empty" position connects to the waste bottle assembly.

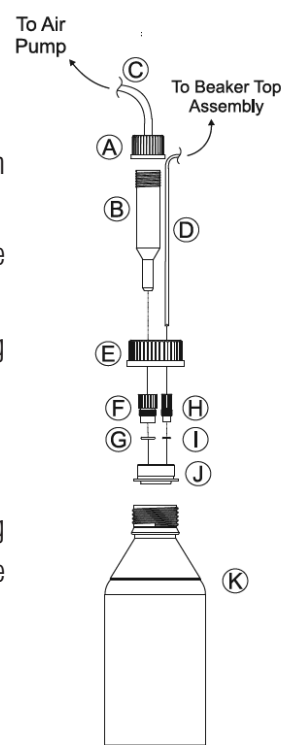

1.4.6. REAGENT EXCHANGE ADAPTER

The Reagent Exchange Adapter is used to connect reagent and waste bottles to the titration vessel. The adapter consists of a set of o-rings and compression caps that form a seal around the reagent and waste tubes, and a ground-glass joint for connection to the titration vessel. The compression caps can be loosened when inserting tubes or adjusting the tube position and tightened to hold the tubes in place. To set up the Reagent Exchange Adapter:

- Loosen the compression caps on the Reagent Exchange Adapter so that the o-rings uncompress.
- Slide the blue PTFE reagent tube (from the reagent bottle assembly) through the cap and o-ring on the right-angle side of the Reagent Exchange Adapter. At least 1 inch of tube should be inside the adapter.
- Tighten the cap until the reagent tube is held in place.
- Slide the blue PTFE waste tube (from the waste bottle assembly) through the cap and o-ring on the straight side of the Reagent Exchange Adapter. At least 1 inch of tube should be inside the adapter.
- Tighten the cap until the waste tube is held in place.
- Place the Reagent Exchange Adapter into the holder.

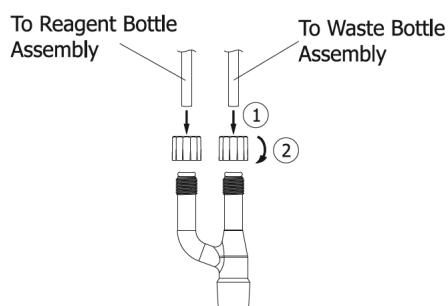

2. USER INTERFACE

2.1. START UP

Once the instrument is assembled and installed, follow the steps below to start the titrator:

- Connect the titrator to a power outlet with the supplied power adapter.
- Turn on the titrator using the power button located on the back of the instrument.
- Wait until the titrator finishes the initialization process.
- Press  key when prompted or wait a few seconds for titrator to start.

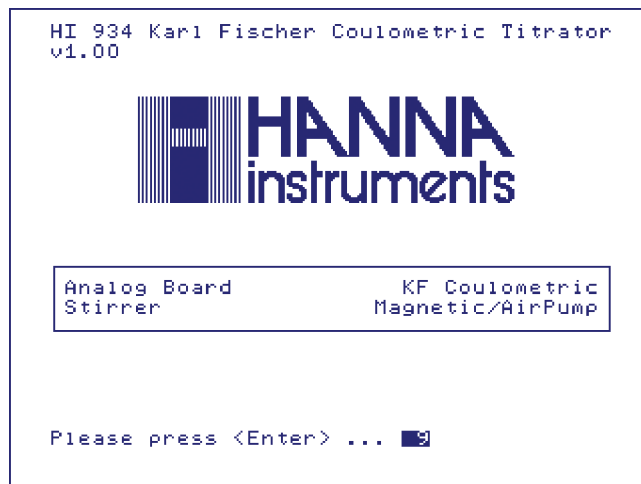

Note: All the performed initialization processes must be successfully completed. If one of the initialization processes fails, restart the titrator. If the problem persists contact your nearest Hanna Instruments Service Center.



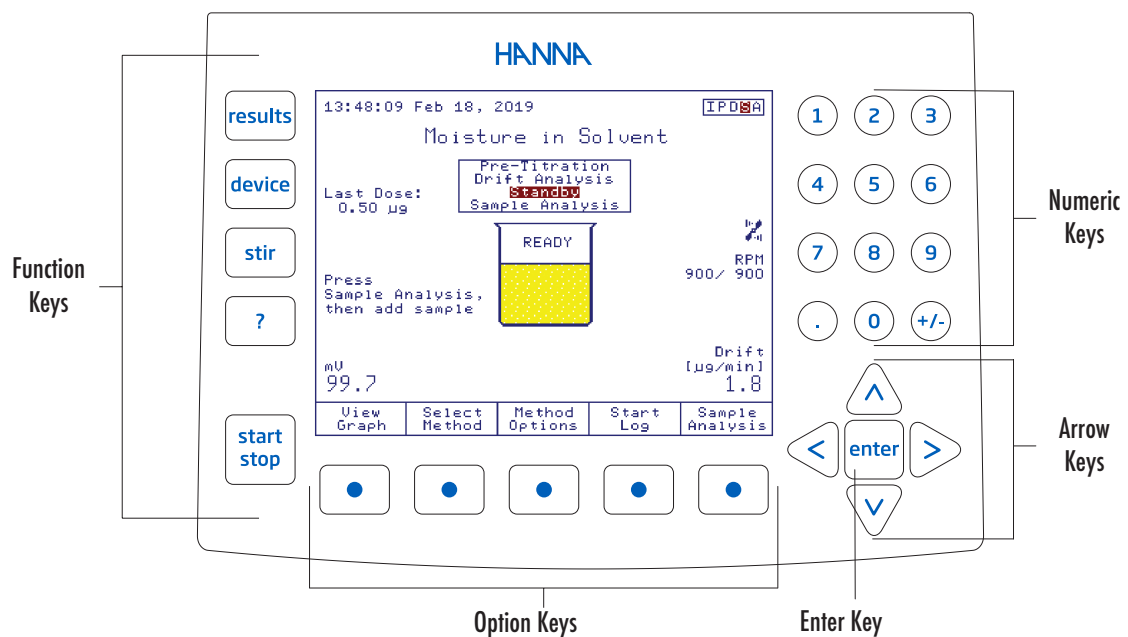

2.2. KEYPAD

The titrator's keypad is grouped into five categories.



2.2.1. FUNCTION KEYS

If one of these keys is pressed, the associated function is immediately performed. Some of the keys are active only in specific screens:

-  Starts or Stops a titration process
-  Turns the selected stirrer On and Off
-  Reserved
-  Access the Data Parameters Menu (reports, GLP, meter information, report setup)
-  Displays Contextual Help

2.2.2. OPTION KEYS

These keys are assigned to the virtual keys on the display. Their functions are listed in the boxes above the buttons and vary depending on the displayed screen.





An underlined virtual key can also be activated by pressing  key.

2.2.3. ARROW KEYS

These keys have the following functions:

- Move the on-screen cursor.
- Increase and decrease the stirrer speed and other settings.
- Select a character (alphanumeric screen only).
- Navigate through menu options.

2.2.4. NUMERIC KEYS

- Keys  to  Used for numeric entries.
-  Toggles between positive and negative values.
-  Used for decimal point.

2.2.5. ENTER KEY

This key has the following functions:

- Accepts alphanumeric data entry.
- Executes the default (underlined) virtual option key.

2.3. DISPLAY

The titrator has a large color graphical display. The main screen is shown below with short explanations of the screen segments.

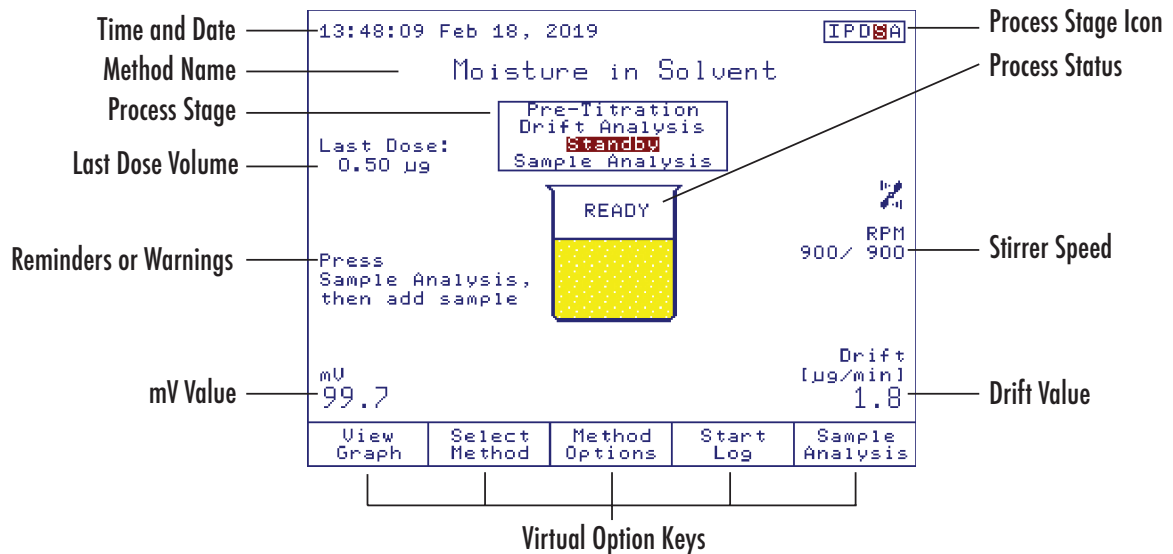

The user interface contains several screens. For each titrator function, several screens may be used.

2.3.1. THE IDLE SCREEN

After start up and initialization, the first screen displayed is the **Idle** screen.

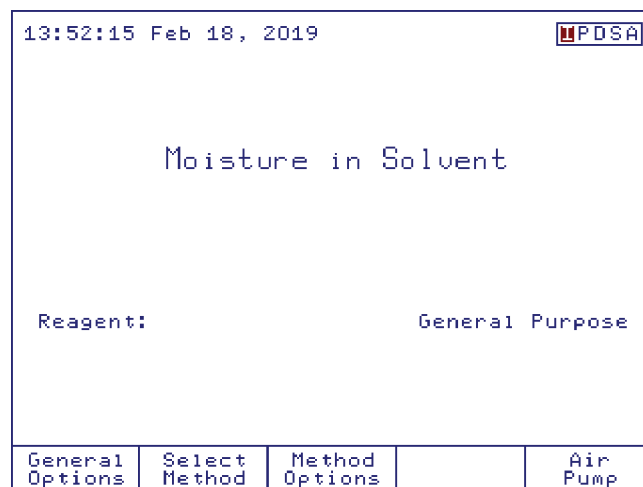

Idle screen fields:

Method Name	Displays the name of the selected method.
Time and Date	Displays the current date and time.
Stirrer Information	Actual / Set stirrer speed is displayed in RPM. When stirrer is off, the stirrer information is not displayed.
Reagent	Displays the name of the current reagent.
Reminders	Indicates when a task needs to be performed and displays error or warning messages.
Process Stage Icon	Displays the process status with a descriptive drawing.

2.3.2. THE TITRATION SCREEN

When the user presses **start stop** key while in **Idle**, all titration related processes are started. The titration process consists of **Pre-titration**, **Drift Analysis**, **Standby** and **Sample Analysis**.

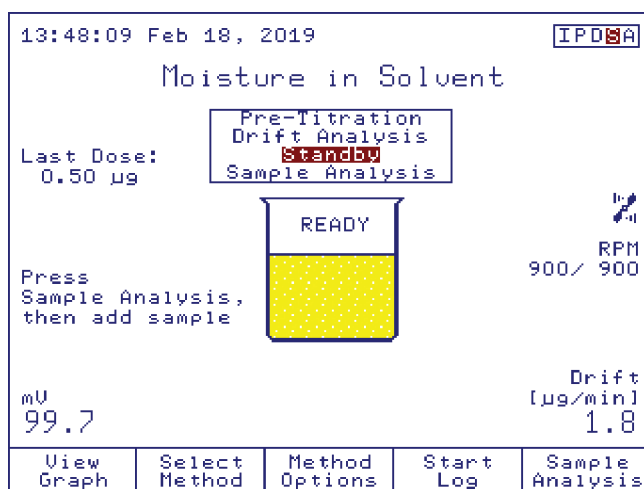

Titration screen fields:

Method Name	Displays the name of the selected method.
Time and Date	Displays the current date and time.
Process Stage Field	Displays the current process (Pre-titration, Drift Analysis, Standby, Sample Analysis).
Process Status	Displays the process status with a descriptive drawing.
mV Reading	Displays the KF electrode potential.
Last Dose	Displays the last generated dose, in μg water.
Drift Value	Displays the drift value, in $\mu\text{g} / \text{min}$ (when available).
Stirrer Information	Actual / Set stirrer speed is displayed in RPM.
Reminders	Indicates when a task needs to be performed and displays error or warning messages.

2.4. MENU NAVIGATION

2.4.1. SELECTING AN OPTION

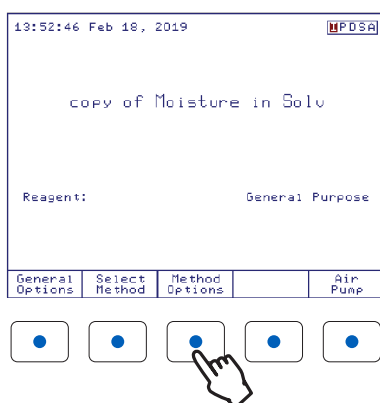

To select an option, press the option key below the virtual key. For example, to access the **Method Options** screen, press the option key below it.

2.4.2. SELECTING A MENU ITEM

View / Modify Method MPD5A

Id: USER0002 Modified: Jun 05, 2019 19:06
Select the option to be modified.

```

Name: copv of Moisture in Solv
Method Revision: 1.0
Type: KF Coulometric
Pre-Analysis Stir Time: 5 Sec
Stirring Speed: 900 RPM
Stirbar Type: Medium
Drift Entry: Automatic
Reagent: General Purpose
Sample Parameters:
Control Parameters:
Termination Parameters:
Result Unit: PPM
  
```

Select Escape Print Method

To select an item from the menu screen, use the Δ and ∇ keys to move the cursor.

When the menu is larger than the display, a scroll bar is active on the right side.

To activate the selected menu item, press enter key or Select.

2.4.3. ENTERING TEXT

Method Name

Select the highlighted letter by using the arrow keys then press <Enter>. Select the empty field for a space. Press <Accept> to save the entire name.

```

A B C D E F G H I J K L M
N O P Q R S T U V W X Y Z
a b c d e f g h i j k l m
n o p q r s t u v w x y z
0 1 2 3 4 5 6 7 8 9 % & '
! " # $ % & ' ( ) * + , - .
: ; < = > ? [ \ ] ^ _ ` {
| } ~ `
  
```

Moisture in Solv

Accept Escape Delete Letter Cursor Left Cursor Right

To enter text in an alphanumeric input box, first erase the previous text by using Delete Letter.

To enter a letter, highlight it using the arrow keys then press enter key. Use the same procedure to enter the whole name.

For editing, use the Cursor Left and Cursor Right.

When editing is complete, press Accept.

The method name will be updated and displayed in the name field of the **View/Modify Method** screen.

When all the desired parameters have been set, press Escape.

View / Modify Method MPD5A

Id: USER0002 Modified: Jun 05, 2019 19:06
Select the option to be modified.

```

Name: Moisture in Solv
Method Revision: 1.0
Type: KF Coulometric
Pre-Analysis Stir Time: 5 Sec
Stirring Speed: 900 RPM
Stirbar Type: Medium
Drift Entry: Automatic
Reagent: General Purpose
Sample Parameters:
Control Parameters:
Termination Parameters:
Result Unit: PPM
Significant Figures: XXXXX
  
```

Select Escape Print Method

2.4.4. SAVING MODIFICATIONS

Saving Method

Select a menu option.

```

Save Method
Exit Without Saving Method
  
```

"Escape" - exits without saving method.

Select Escape

The **Saving Method** screen allows the user to save the modifications. To exit without saving, press Escape or highlight *Exit Without Saving Method* option and then press Select. To save the modifications highlight *Save Method* option and then press Select.

Note: To access the contextual help menu, press ? key at any time. Help is related to the displayed screen. Press

Escape or ? key to return to the previous screen.

3. GENERAL OPTIONS

The **General Options** screen gives access to options that are not directly related to the titration process. In **Idle** mode, on the main screen press  to access this screen. In **Pre-titration**, **Standby** or during an **Analysis** press the <<Home>> key on a PS/2 keyboard to access this screen.

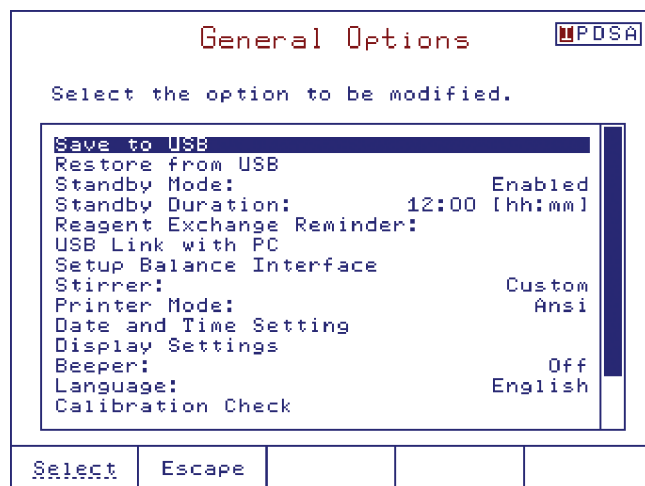

3.1. SAVE FILES TO USB STORAGE DEVICE

This option allows the user to save files from the titrator to a USB storage device.

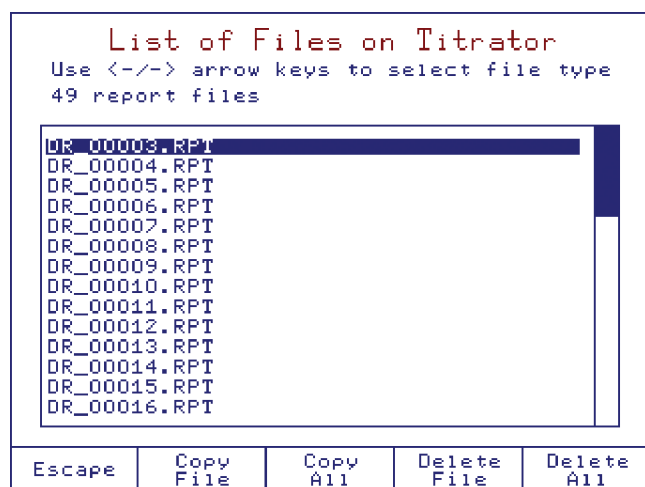

On the titrator, the available file types are:

Standard Methods	HIXXXYY.MTD (e.g.: HI9001EN.MTD, HI9101EN.MTD)
User Methods	USERXXX.MTD (e.g.: USER0001.MTD)
Drift/Titration Reports	DR_XXXX.RPT, KF_XXXX.RPT (e.g.: DR_00001.RPT, KF_00001.RPT)

Insert the USB storage device into the USB port on the right side of the titrator.

Use the << and >> keys to select the file type. The number of files and the file names will be displayed.

Use the ▲ and ▼ keys to scroll through the list.

The option keys allow the following operations:

Escape	Returns to the General Options screen.
Copy File	Copies the highlighted file from the titrator to the USB storage device.
Copy All	Copies all currently displayed files from the titrator to the USB storage device.
Delete File	Deletes the highlighted file.
Delete All	Deletes all currently displayed files.

Note: The saved files will be stored on the USB key in the **HI934** folder, as follows:

- Methods: **USB Drive\HI934\Methods*.mtd**
- Reports: **USB Drive\HI934\Reports*.rpt**

Note: The USB Storage Device has to be formatted FAT or FAT32.

3.2. RESTORE FILES FROM USB STORAGE DEVICE

This option allows the user to transfer files from the USB storage device to the titrator.

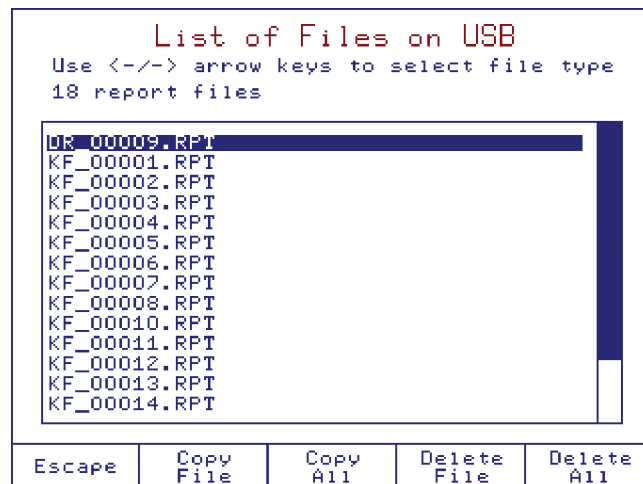

The file types that can be transferred are:

Standard Methods	HIXXXYY.MTD (e.g.: HI9001EN.MTD, HI9101EN.MTD)
User Methods	USERXXX.MTD (e.g.: USER0001.MTD)
Drift/Titration Reports	DR_XXXX.RPT, KF_XXXX.RPT (e.g.: DR_00001.RPT, KF_00001.RPT)

Insert the USB storage device into the USB port on the right side of the titrator.

Use the < and > keys to select the file type. The number of files and the file names will be displayed.

Use the ^ and v keys to scroll through the list.

The option keys allow the following operations:

Escape	Returns to the General Options screen.
Copy File	Copies the highlighted file from the USB storage to the titrator.
Copy All	Copies all currently displayed files from the USB storage to the titrator.
Delete File	Deletes the highlighted file.
Delete All	Deletes all currently displayed files.

Note: In order to restore files from USB Key, please ensure that the methods and/or reports you wish to transfer to the titrator are in the correct folder:

- Methods: **USB Drive\HI934\Methods*.mtd**
- Reports: **USB Drive\HI934\Reports*.rpt**

Note: The USB Storage Device has to be formatted FAT or FAT32.

3.3. STANDBY MODE

Option: Disabled or Enabled

When enabling this option the titrator will return to **Standby** mode automatically after the titration has been completed.

Standby Mode														
Select the option for standby mode.														
<table border="1"> <tr> <td>Disabled</td> <td></td> <td></td> <td></td> <td></td> </tr> <tr> <td>Enabled</td> <td></td> <td></td> <td></td> <td></td> </tr> </table>					Disabled					Enabled				
Disabled														
Enabled														
Select	Escape													

3.4. STANDBY DURATION

Option: 10 minutes to 72 hours

The user can enter the period of time for which the cell is kept dry and ready for subsequent analysis after a titration has finished.

Standby Duration				
Enter time period (at least 10 min.) for which titrator will run in standby mode.				
hours		minutes		
72		00		
Low Limit: 00:10				
High Limit: 72:00				
Press <Next> to move to the next entry.				
Accept	Escape	Delete Digit	Next	

3.5. REAGENT EXCHANGE REMINDER

Reagent Exchange Reminder										
Select the option.										
<table border="1"> <tr> <td>Timer:</td> <td>2days, 0hours</td> </tr> <tr> <td>Water Consumption:</td> <td>1000.0 mg</td> </tr> <tr> <td>Reset Reminder</td> <td></td> </tr> </table>					Timer:	2days, 0hours	Water Consumption:	1000.0 mg	Reset Reminder	
Timer:	2days, 0hours									
Water Consumption:	1000.0 mg									
Reset Reminder										
Select	Escape									

3.5.1. REAGENT EXCHANGE TIMER

Option: Disabled to 31 days and 23 hours

A warning message will be displayed on the screen after the set period of time has elapsed.

Reagent Exchange Timer				
Enter the time allowed to elapse before the reagent exchange reminder appears.				
days		hours		
2		0		
Press <Next> to move to the next entry.				
Accept	Escape	Delete Digit	Next	Disable

3.5.2. WATER CONSUMPTION

Option: 100.0 to 5000.0 mg

A warning message will be displayed on the screen when the reagent has consumed the set amount of water.

Water Consumption Reminder				
Enter the water consumption amount after that the reagent exchange reminder will appear.				
1000.0 mg				
Low Limit: 100.0 mg High Limit: 5000.0 mg				
Accept	Escape	Delete Digit		

3.5.3. RESET REMINDER

The reagent exchange reminder will be reset.

Confirmation of Reset Reminder				
Are you sure you want to reset reagent exchange reminder?				
Reset	Escape			

3.6. USB LINK WITH PC

In order to use this feature, the USB cable needs to be connected from the titrator to the PC. Make sure that **HI900** PC application is running on the PC.

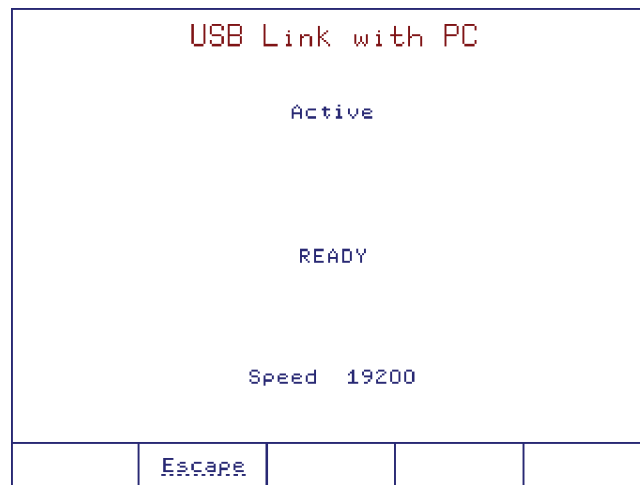

“Active / Inactive” shows the status of the USB link with the PC.

“Active” means that the titrator is using the USB communication with the PC and not with another device.

“Ready” shows that the titrator is able to communicate with the PC.





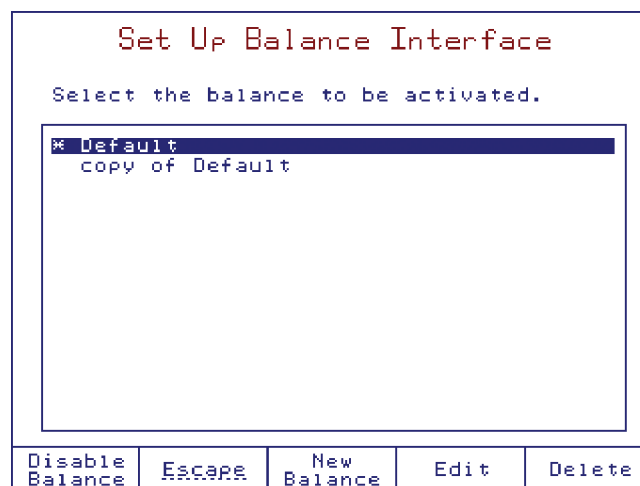

“Transmit” and the status is shown during data transfer.

3.7. SETUP BALANCE INTERFACE

This option allows the user to setup an analytical balance for automatic acquisition of sample mass prior to titration.



The balance is connected to the titrator via RS 232 interface.

-  Enables the selected balance.
-  Disables the selected balance (automatic weight acquisition will be not available).
-  Returns to the **General Options** screen.
-  Adds a new balance to the list.
-  Customizes the serial communication parameters for the highlighted balance. The **Balance Configuration** screen will open.
-  Deletes the highlighted balance.

Note: At least one balance must be in the list.

The balance configuration settings must match the settings for your balance, the setting on the titrator or balance may need to be changed. Users should consult their balance instruction manual.

To test the connection with the balance press .

Balance Configuration	
Select the option to be modified.	
Balance Name	Default
Baud Rate	9600
Data Bits	8 Bits
Parity	No Parity
Stop Bit	1 bit
Edit Request Command	B

Select	Escape		Test Balance	
--------	--------	--	--------------	--

3.8. STIRRER

Option: Internal, External, Custom

This option allows the user to select an internal, external or custom (user-controlled) stirrer.

Stirrer	
Select the option.	
Internal	
External	
Custom	

Select	Escape			
--------	--------	--	--	--

3.9. PRINTER MODE

Option: Ansi, Ascii, Text

Printer Mode							
Select the option.							
<table border="1"> <tr> <td>Ansi</td> </tr> <tr> <td>Ascii</td> </tr> <tr> <td>Text</td> </tr> </table>					Ansi	Ascii	Text
Ansi							
Ascii							
Text							
Select	Escape						

Ansi Use this mode when the printer is set as Ansi. All the accented characters and symbols available in titrator will be printed on the printer.

Ascii Use this mode when the printer is set as Ascii. In this case only some of the accented characters and symbols available in titrator will be printed on the printer.



Text This mode is recommended when the user doesn't need to print accented characters.

3.10. DATE AND TIME SETTING

This option allows the user to set the date and time.

Use the  and  keys or the numeric keys to modify the date and time.

Press  to move the cursor to the next field.

Press  or  to change the time format.

Date and Time Setting				
Enter the date.				
	10	2018		
day	month	year		
Enter the time.				
20	41	41		
hour	minute	second		
Press <Next> to move to the next entry.				
Accept	Escape	Delete Digit	Next	AM/PM

3.11. DISPLAY SETTINGS

This option allows the user to customize the display settings.

Option Keys



Increases the backlight saver time interval



Decreases the backlight saver time interval

The backlight intensity can be adjusted using the and keys.

There are 8 levels of backlight intensity, ranging from 0 to 7.

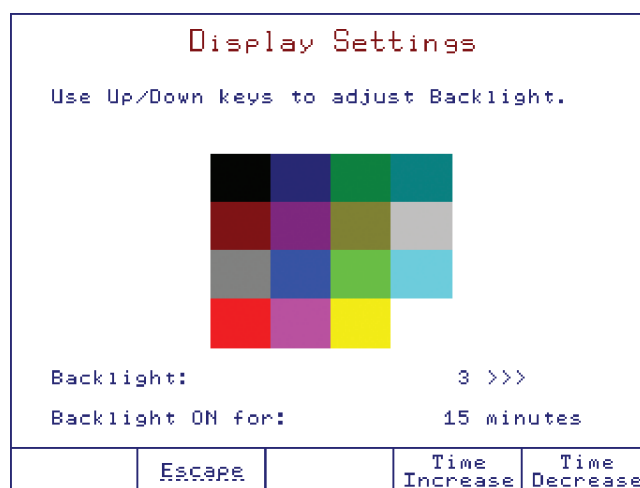

The displayed color palette allows for selection of appropriate backlight intensity.

The backlight saver option protects the display during standby periods, when no keys have been pressed for the set amount of time the backlight will turn off.

If the backlight is off, any keystroke will re-activate the backlight without performing any action.

The range for backlight saver interval is between 1 and 60 minutes. To disable the backlight saver, increase the time to the maximum allowed, the "Off" indication will appear.

3.12. BEEPER

Option: On or Off

If enabled (on) an audible alert will sound after a titration is completed, when an invalid key is pressed or when a critical error occurs during titration.

Beeper						
Select the option.						
<table border="1"><tr><td>Beeper Off</td></tr><tr><td>Beeper On</td></tr></table>					Beeper Off	Beeper On
Beeper Off						
Beeper On						
Select	Escape					

3.13. LANGUAGE

Option: English, Español, Português, Français

Set Language								
Select the language.								
<table border="1"><tr><td>English</td></tr><tr><td>Español</td></tr><tr><td>Português</td></tr><tr><td>Français</td></tr></table>					English	Español	Português	Français
English								
Español								
Português								
Français								
Select	Escape							

3.14. CALIBRATION CHECK

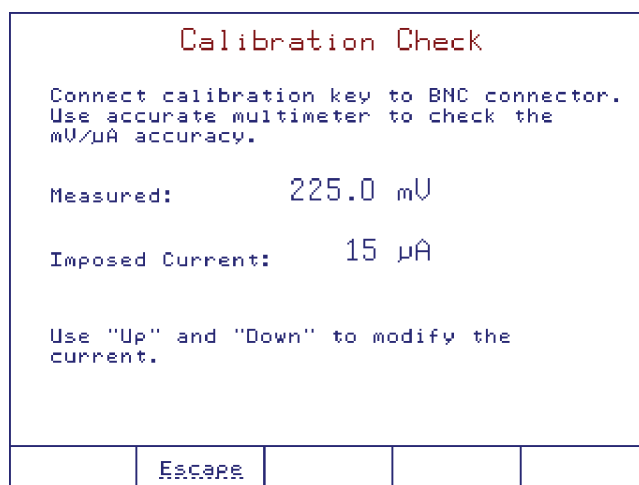

This option allows the user to verify the electrode mV input and the electrode polarization current.



The electrode mV input and the electrode polarization current are measured with the **HI900940** calibration key and a mV/µA multimeter (not included).

Disconnect the KF electrode, then connect the **HI900940** calibration key to the electrode input (BNC connector).

To check the mV input:

- 1) Set the multimeter to mV mode.
- 2) Switch the calibration key to mV mode by pressing the red button.
- 3) Connect the calibration key banana plugs to the multimeter mV input.
- 4) Use the  and  keys to change the imposed current (predefined list).
- 5) The millivolt reading displayed on the titrator screen should be within 2% of the reading on the multimeter.

To check the µA output:

- 1) Set the multimeter to µA mode.
- 2) Switch the calibration key to µA mode by pressing the red button.
- 3) Connect the calibration key banana plugs to the multimeter µA input.
- 4) The reading on the multimeter should be in accordance with the prescribed µA value on the titrator screen.

3.15. RESET TO DEFAULT SETTINGS

This will delete all the user methods and restore all manufacturer settings such as titrator configuration, standard method parameters, etc.



3.16. OPTIMIZE MEMORY SPACE

This option allows the user to run a memory defragmentation utility in order to optimize memory space.

Press and then restart the titrator. Do not disconnect the power supply during this operation.

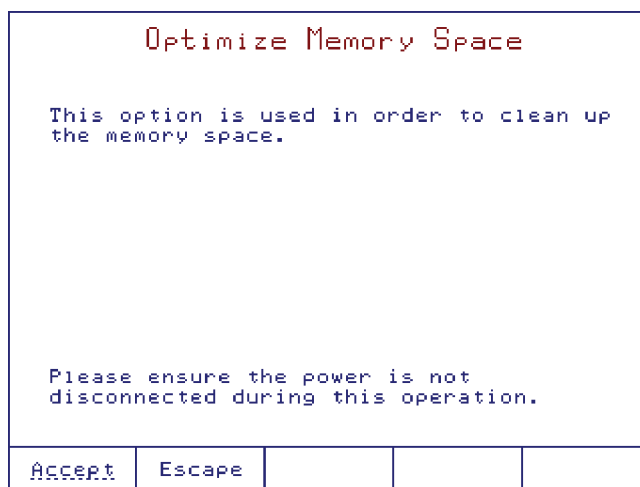

3.17. UPDATE SOFTWARE

This screen allows the user to update the titrator software from a USB storage device containing a software setup kit.

Update Software				
Current version:	HI934	v1.00		
New version:	HI934	v1.01		
Are you sure you want to update the current software with the new version?				
Accept	Escape	Refresh		

To update the software:

- Copy the “**Setup934**” folder to a USB storage device.
- Insert the USB storage device into the titrator.
- Go to **General Options**, then **Update Software**. The titrator will display the current and new software versions.
- Press when prompted, remove the USB storage device and restart the titrator.

4. TITRATION METHODS

All parameters required to complete an analysis are grouped into a method.

The titrator is supplied with a pack of standard methods, these methods have been developed by Hanna Instruments and can be used to create user methods.

Standard and user methods can be upgraded, saved or deleted by connecting the titrator to a PC using the **HI900** PC application or a USB flash drive.

4.1. SELECTING METHODS

To select a method, press  from the main screen. A list of available methods will be displayed.

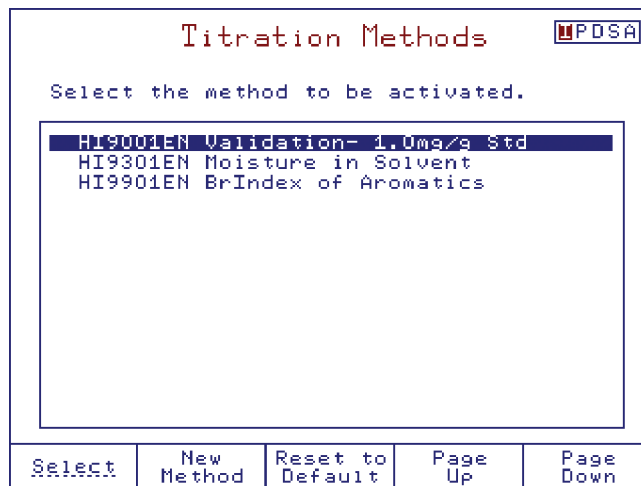

In the **Titration Methods** screen, you can view the list of all available methods (standard and user methods).

To select a method, highlight the method then press  the name of the selected method will be displayed on the main screen.

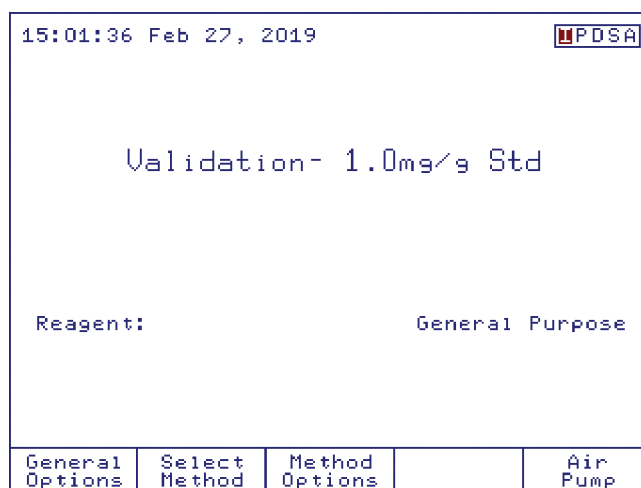

4.2. STANDARD METHODS

The standard methods are developed for the most common types of analysis.

Only specific method parameters can be modified by the user (see **4.5. METHOD OPTIONS** section).

Also, standard methods can be used as a template to create new user methods.

4.2.1. UPGRADING STANDARD METHODS

To upgrade the titrator with new standard methods, follow the steps below:

From USB storage device

- 1) Insert the USB storage device into the USB port, located on the right side of the titrator.
- 2) Press **General Options** from the main screen.
- 3) Using **▲** and **▼** keys, highlight *Restore from USB Storage Device* option and choose **Select**.
- 4) Using **<** and **>** keys, navigate through file types to find "standard method files". The list with available standard methods will be displayed.
- 5) Press the **Copy File** or **Copy All** to upgrade the titrator with the standard methods.
- 6) Press **Escape** to return to **General Options** screen.

From PC

Use the **HI900** PC application (see **3. GENERAL OPTIONS** section).

4.2.2. DELETING STANDARD METHODS

Unnecessary standard methods can be removed from the titrator by following the procedure below:

From General Options Screen

- 1) Using the **▲** and **▼** keys, highlight *Save to USB* option and press **Select**.
- 2) Using the **<** and **>** keys, navigate through the file types menu to find "standard method files". The available standard methods will be displayed.
- 3) Press the **Delete** or **Delete All** to remove unnecessary standard methods.
- 4) Press **Escape** to return to the **General Options** screen.

From PC

Use the **HI900** PC application (see **3. GENERAL OPTIONS** section).

4.2.3. RESTORING THE STANDARD METHODS TO THE MANUFACTURER SETTINGS

You can restore the standard methods to the default settings by highlighting a standard method and pressing **Reset to Default**.

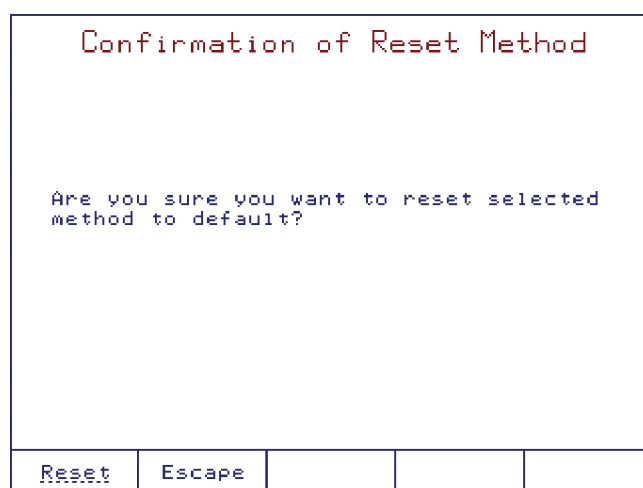

4.3. USER METHODS

These methods are defined by the user (usually by modifying a standard method).

The user methods can be developed in accordance with the requirements of the user. All method parameters can be modified by the user.

4.3.1. CREATING USER METHODS

To create a new user method, start from a standard or previously generated user method and follow these steps:

- 1) Press from the main screen.
- 2) Using the and keys, highlight an existing method from the method list.
- 3) Press , a new user method will be generated.
- 4) Press to activate the recently generated user method.

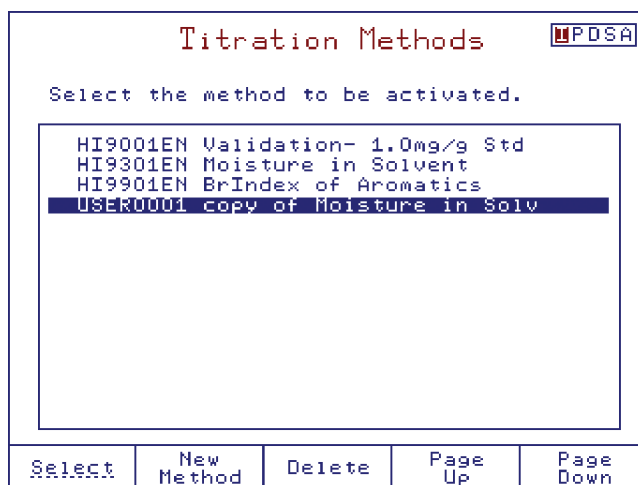

Note: The titrator can hold 100 methods (standard and user defined). When the limit is reached, a warning message is displayed.

4.3.2. DELETING USER METHODS

To remove a user method, press from the main screen. Highlight the user method that you want to delete and press . A screen will appear in order to confirm the deletion. Press again to confirm, or press to cancel the operation.

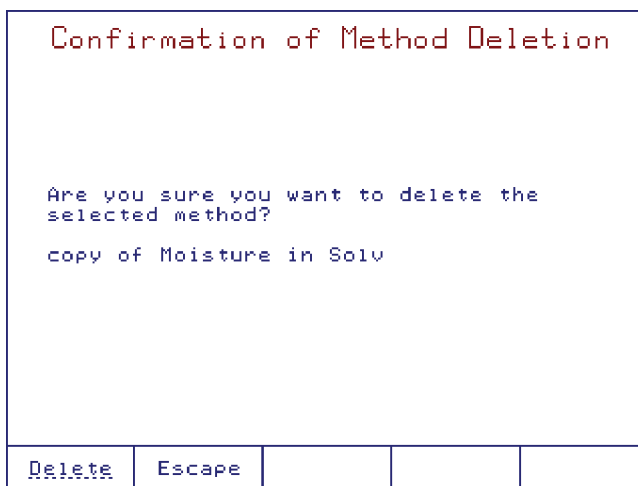

4.4. VIEWING / MODIFYING METHOD

To modify the method parameters, press Method Options from the main screen. A list of all the parameters for the selected method will be displayed. Press the ▲ and ▼ keys to highlight the option you want to modify and press Select.

View / Modify Method		PDSA
Id: USER0002 Modified: Jun 05, 2019 19:06		
Select the option to be modified.		
<pre> Name: copy of Moisture in Solv Method Revision: 1.0 Type: KF Coulometric Pre-Analysis Stir Time: 5 Sec Stirring Speed: 900 RPM Stirbar Type: Medium Drift Entry: Automatic Reagent: General Purpose Sample Parameters: Control Parameters: Termination Parameters: Result Unit: PPM Significant Figures: XXXXX </pre>		
Select	Escape	Print Method

To exit the **View / Modify Method** screen, press the Escape, and highlight *Save Method*. Press Select to save modifications.

Press Escape to discard the changes.

Saving Method	
Select a menu option.	
<pre> Save Method Exit Without Saving Method </pre>	
"Escape" - exits without saving method.	
Select	Escape

4.5. METHOD OPTIONS

Note: Some options cannot be modified if a standard method is selected.

4.5.1. METHOD NAME

Option: Up to 24 characters

Method Name				
Select the highlighted letter by using the arrow keys then press <Enter>. Select the empty field for a space. Press <Accept> to save the entire name.				
<pre> M B C D E F G H I J K L M N O P Q R S T U V W X Y Z a b c d e f g h i j k l m n o p q r s t u v w x y z A A A A C E E E I I N O O 0 0 0 0 0 0 0 0 0 0 0 0 0 i i ñ ò ó ô õ ö ù ú û ü 0 1 2 3 4 5 6 7 8 9 % # \$. , ? ! () [] < > = + - * / \ _ ^ ` : </pre>				
Moisture in Solu				
Accept	Escape	Delete Letter	Cursor Left	Cursor Right

4.5.2. METHOD REVISION

Option: Up to 3 characters

Method Revision				
Select the highlighted letter by using the arrow keys then press <Enter>. Select the empty field for a space. The revision string format is "X.X".				
<pre> M B C D E F G H I J K L M N O P Q R S T U V W X Y Z a b c d e f g h i j k l m n o p q r s t u v w x y z A A A A C E E E I I N O O 0 0 0 0 0 0 0 0 0 0 0 0 0 i i ñ ò ó ô õ ö ù ú û ü 0 1 2 3 4 5 6 7 8 9 % # \$. , ? ! () [] < > = + - * / \ _ ^ ` : </pre>				
1.0				
Accept	Escape	Delete Letter	Cursor Left	Cursor Right

4.5.3. METHOD TYPE

Option: KF Coulometric, Bromine Index

Method Type														
Choose the method application type.														
<table border="1"> <tr> <td><input checked="" type="checkbox"/> KF Coulometric</td> <td colspan="4"></td> </tr> <tr> <td><input type="checkbox"/> Bromine Index</td> <td colspan="4"></td> </tr> </table>					<input checked="" type="checkbox"/> KF Coulometric					<input type="checkbox"/> Bromine Index				
<input checked="" type="checkbox"/> KF Coulometric														
<input type="checkbox"/> Bromine Index														
Select	Escape													

4.5.4. PRE-ANALYSIS STIR TIME

Option: 0 to 1000 seconds

To avoid erroneous results or unreachable endpoints when analyzing samples with limited solubility, the sample must be completely dissolved in the reagent prior to the start of a titration.

After the sample has been added to the titration beaker, the titrator will stir for the set period of time before any iodine is generated or bromine is consumed.

Pre-Analysis Stir Time									
Enter the initial mixing time prior to the start of the titration.									
<table border="1"> <tr> <td></td> <td>10</td> <td>seconds</td> <td colspan="2"></td> </tr> </table>						10	seconds		
	10	seconds							
Low Limit: 0 seconds									
High Limit: 1000 seconds									
Accept	Escape	Delete Digit							

4.5.5. STIRRER SPEED

Option: 200 to 2000 RPM

Stirring Speed				
Enter the speed of the stirrer during the titration.				
500 RPM				
Low Limit: 200 RPM High Limit: 2000 RPM				
Accept	Escape	Delete Digit		

The stirrer will remain on for as long as the method is active. When the stirrer is running, the speed can be adjusted at any time by using the \triangle and ∇ keys.

4.5.6. STIRBAR TYPE

Option: Up to 10 characters

Stirbar Type													
Select the highlighted letter by using the arrow keys then press <Enter>. Select the empty field for a space. Press <Accept> to save the stirbar type.													
<input checked="" type="checkbox"/>	B	C	D	E	F	G	H	I	J	K	L	M	
	N	O	P	Q	R	S	T	U	V	W	X	Y	Z
	a	b	c	d	e	f	g	h	i	j	k	l	m
	n	o	p	q	r	s	t	u	v	w	x	y	z
	A	A	A	A	D	E	E	E	I	I	N	O	O
	ó	ó	ó	ó	á	á	á	á	é	é	é	é	é
	i	i	ñ	ó	ó	ó	ó	ú	ú	ú	ú	ú	i
	0	1	2	3	4	5	6	7	8	9	%	#	\$
	.	,	?	!	()	[]	<	>	=	+	-
	*	/	\	_	^	'	:						
Medium													
Accept	Escape	Delete Letter	Cursor Left	Cursor Right									

4.5.7. DRIFT ENTRY

Option: Automatic or User

Drift Entry				
Choose the drift entry mode.				
<div style="border: 1px solid black; padding: 2px;"> Automatic User </div>				
Select	Escape			

Automatic The drift rate will be calculated automatically after the pre-titration of the reagent.

User The drift is set to a fixed value (entered by the user). The user enters the estimated drift value. The drift analysis stage will be skipped.

User Drift Value				
Enter the background drift value for final result correction.				
<div style="border: 1px solid black; display: inline-block; padding: 2px;">8.0</div> $\mu\text{g}/\text{min}$				
Low Limit: 0.0 $\mu\text{g}/\text{min}$ High Limit: 10.0 $\mu\text{g}/\text{min}$				
Accept	Escape	Delete Digit		

4.5.8. REAGENT NAME

Option: Up to 15 characters

Reagent Name																																																																																																																										
Select the highlighted letter by using the arrow keys then press <Enter>. Select the empty field for a space. Press <Accept> to save the entire name.																																																																																																																										
<table style="border-collapse: collapse; width: 100%;"> <tr><td style="border: 1px solid black;">A</td><td>B</td><td>C</td><td>D</td><td>E</td><td>F</td><td>G</td><td>H</td><td>I</td><td>J</td><td>K</td><td>L</td><td>M</td></tr> <tr><td>N</td><td>O</td><td>P</td><td>Q</td><td>R</td><td>S</td><td>T</td><td>U</td><td>V</td><td>W</td><td>X</td><td>Y</td><td>Z</td></tr> <tr><td>a</td><td>b</td><td>c</td><td>d</td><td>e</td><td>f</td><td>g</td><td>h</td><td>i</td><td>j</td><td>k</td><td>l</td><td>m</td></tr> <tr><td>n</td><td>o</td><td>p</td><td>q</td><td>r</td><td>s</td><td>t</td><td>u</td><td>v</td><td>w</td><td>x</td><td>y</td><td>z</td></tr> <tr><td>À</td><td>Á</td><td>Â</td><td>Ã</td><td>Ä</td><td>Å</td><td>Æ</td><td>Ç</td><td>È</td><td>É</td><td>Ê</td><td>Ë</td><td>Ì</td></tr> <tr><td>Í</td><td>Î</td><td>Ï</td><td>Ñ</td><td>Ò</td><td>Ó</td><td>Ô</td><td>Õ</td><td>Ö</td><td>×</td><td>÷</td><td>ü</td><td>ÿ</td></tr> <tr><td>0</td><td>1</td><td>2</td><td>3</td><td>4</td><td>5</td><td>6</td><td>7</td><td>8</td><td>9</td><td>%</td><td>#</td><td>\$</td></tr> <tr><td>.</td><td>,</td><td>?</td><td>!</td><td>(</td><td>)</td><td>[</td><td>]</td><td><</td><td>></td><td>=</td><td>+</td><td>-</td></tr> <tr><td>*</td><td>/</td><td>\</td><td>_</td><td>~</td><td>^</td><td>'</td><td>:</td><td colspan="5"></td></tr> </table>						A	B	C	D	E	F	G	H	I	J	K	L	M	N	O	P	Q	R	S	T	U	V	W	X	Y	Z	a	b	c	d	e	f	g	h	i	j	k	l	m	n	o	p	q	r	s	t	u	v	w	x	y	z	À	Á	Â	Ã	Ä	Å	Æ	Ç	È	É	Ê	Ë	Ì	Í	Î	Ï	Ñ	Ò	Ó	Ô	Õ	Ö	×	÷	ü	ÿ	0	1	2	3	4	5	6	7	8	9	%	#	\$.	,	?	!	()	[]	<	>	=	+	-	*	/	\	_	~	^	'	:					
A	B	C	D	E	F	G	H	I	J	K	L	M																																																																																																														
N	O	P	Q	R	S	T	U	V	W	X	Y	Z																																																																																																														
a	b	c	d	e	f	g	h	i	j	k	l	m																																																																																																														
n	o	p	q	r	s	t	u	v	w	x	y	z																																																																																																														
À	Á	Â	Ã	Ä	Å	Æ	Ç	È	É	Ê	Ë	Ì																																																																																																														
Í	Î	Ï	Ñ	Ò	Ó	Ô	Õ	Ö	×	÷	ü	ÿ																																																																																																														
0	1	2	3	4	5	6	7	8	9	%	#	\$																																																																																																														
.	,	?	!	()	[]	<	>	=	+	-																																																																																																														
*	/	\	_	~	^	'	:																																																																																																																			
<div style="border: 1px solid black; display: inline-block; padding: 2px;">General Purpose</div>																																																																																																																										
Accept	Escape	Delete Letter	Cursor Left	Cursor Right																																																																																																																						

4.5.9. SAMPLE PARAMETERS

This screen allows the user to configure parameters for the sample to be analyzed.

Sample Parameters				
Select the option to be modified.				
Sample Determ.:	Normal			
Sample Name:	Default Sample			
Sample Type:	Mass			
Sample Size:	1.0000 g			
Select	Escape			

4.5.9.1. SAMPLE DETERMINATION

Option: Normal, External Extraction, External Dissolution

Sample Determination				
Select the sample determination mode.				
Normal				
External Extraction				
External Dissolution				
Select	Escape			

Normal

The analysis is performed through direct titration of liquid samples that are soluble in the solvent and have homogeneous distribution in water.

External Extraction

The sample is insoluble in the reagent and an external water extraction is necessary.

External Dissolution

The sample has very high water content, non-homogeneous water distribution, or is slow to dissolve. The sample is dissolved in a separate container and then a small amount of the reagent is titrated.

See [8. METHOD OPTIMIZATION](#) section for further details.

4.5.9.1.1. NORMAL

Sample Parameters												
Select the option to be modified.												
<table border="1"> <tr> <td>Sample Determ.:</td> <td>Normal</td> </tr> <tr> <td>Sample Name:</td> <td>Default Sample</td> </tr> <tr> <td>Sample Type:</td> <td>Mass</td> </tr> <tr> <td>Sample Size:</td> <td>0.7500 g</td> </tr> </table>					Sample Determ.:	Normal	Sample Name:	Default Sample	Sample Type:	Mass	Sample Size:	0.7500 g
Sample Determ.:	Normal											
Sample Name:	Default Sample											
Sample Type:	Mass											
Sample Size:	0.7500 g											
Select	Escape											

Sample Name

Option: Up to 15 characters

Sample Name				
Select the highlighted letter by using the arrow keys then press <Enter>. Select the empty field for a space. Press <Accept> to save the sample name.				
<pre> M B C D E F G H I J K L M N O P Q R S T U V W X Y Z a b c d e f g h i j k l m n o p q r s t u v w x y z À Á Â Ã Ä Å Æ Ç È É Ê Ë Ì Í Î Ï Ñ Ò Ó Ô Õ Ö Ø Ù Ú Û Ü 0 1 2 3 4 5 6 7 8 9 / # % * , ? ! () [] < > = + - _ ` ^ ' : ; </pre>				
Default Sample				
Accept	Escape	Delete Letter	Cursor Left	Cursor Right

Sample Type

Option: Mass or Volume

Sample Type						
Choose the sample amount type.						
<table border="1"> <tr> <td>Mass</td> </tr> <tr> <td>Volume</td> </tr> </table>					Mass	Volume
Mass						
Volume						
Select	Escape					

Sample Size

Option: 0.0010 to 100.0000 g or 0.0010 to 100.0000 mL

Sample Size				
Enter the sample size in current unit.				
1.0000 g				
Low Limit: 0.0010 g				
High Limit: 100.0000 g				
ACCEPT	Escape	Delete Digit		

Sample Size				
Enter the sample size in current unit.				
1.0000 mL				
Low Limit: 0.0010 mL				
High Limit: 100.0000 mL				
ACCEPT	Escape	Delete Digit		

Sample Density (by volume only)

Option: 0.200 to 3.000 g/mL

Sample Density				
Enter the value of sample density.				
1.000 g/mL				
Low Limit: 0.200 g/mL				
High Limit: 3.000 g/mL				
ACCEPT	Escape	Delete Digit		

4.5.9.1.2. EXTERNAL EXTRACTION

Sample Parameters																																		
Select the option to be modified.																																		
<table border="1"> <tr> <td>Sample Determ.:</td> <td colspan="4">External Extraction</td> </tr> <tr> <td>Sample Name:</td> <td colspan="4">Default Sample</td> </tr> <tr> <td>Sample Size:</td> <td colspan="4">1.0000 g</td> </tr> <tr> <td>External Solvent Size:</td> <td colspan="4">0.2500 g</td> </tr> <tr> <td>External Solvent Conc.:</td> <td colspan="4">10.0000 mg/g</td> </tr> <tr> <td>Extracted Sample Size:</td> <td colspan="4">0.2500 g</td> </tr> </table>					Sample Determ.:	External Extraction				Sample Name:	Default Sample				Sample Size:	1.0000 g				External Solvent Size:	0.2500 g				External Solvent Conc.:	10.0000 mg/g				Extracted Sample Size:	0.2500 g			
Sample Determ.:	External Extraction																																	
Sample Name:	Default Sample																																	
Sample Size:	1.0000 g																																	
External Solvent Size:	0.2500 g																																	
External Solvent Conc.:	10.0000 mg/g																																	
Extracted Sample Size:	0.2500 g																																	
Select	Escape																																	

Sample Name

Option: Up to 15 characters

Sample Name																																																																																																																																																																																																																				
Select the highlighted letter by using the arrow keys then press <Enter>. Select the empty field for a space. Press <Accept> to save the sample name.																																																																																																																																																																																																																				
<table border="1"> <tr> <td>B</td><td>C</td><td>D</td><td>E</td><td>F</td><td>G</td><td>H</td><td>I</td><td>J</td><td>K</td><td>L</td><td>M</td> </tr> <tr> <td>N</td><td>O</td><td>P</td><td>Q</td><td>R</td><td>S</td><td>T</td><td>U</td><td>V</td><td>W</td><td>X</td><td>Y</td><td>Z</td> </tr> <tr> <td>a</td><td>b</td><td>c</td><td>d</td><td>e</td><td>f</td><td>g</td><td>h</td><td>i</td><td>j</td><td>k</td><td>l</td><td>m</td> </tr> <tr> <td>n</td><td>o</td><td>p</td><td>q</td><td>r</td><td>s</td><td>t</td><td>u</td><td>v</td><td>w</td><td>x</td><td>y</td><td>z</td> </tr> <tr> <td>À</td><td>Á</td><td>Â</td><td>Ã</td><td>Ä</td><td>Å</td><td>Ç</td><td>È</td><td>É</td><td>Ê</td><td>Ë</td><td>Ì</td><td>Í</td><td>Î</td><td>Ï</td><td>Ð</td><td>Ñ</td><td>Ò</td><td>Ó</td><td>Ô</td><td>Õ</td><td>Ö</td><td>×</td><td>÷</td><td>¸</td><td>¸</td><td>¸</td> </tr> <tr> <td>ì</td><td>í</td><td>î</td><td>ï</td><td>ò</td><td>ó</td><td>ô</td><td>õ</td><td>ö</td><td>÷</td><td>¸</td><td>¸</td><td>¸</td><td>¸</td><td>¸</td><td>¸</td><td>¸</td><td>¸</td><td>¸</td><td>¸</td><td>¸</td><td>¸</td><td>¸</td><td>¸</td><td>¸</td><td>¸</td><td>¸</td><td>¸</td> </tr> <tr> <td>0</td><td>1</td><td>2</td><td>3</td><td>4</td><td>5</td><td>6</td><td>7</td><td>8</td><td>9</td><td>%</td><td>#</td><td>\$</td><td></td><td></td><td></td><td></td><td></td><td></td><td></td><td></td><td></td><td></td><td></td><td></td><td></td><td></td><td></td> </tr> <tr> <td>*</td><td>/</td><td>?</td><td>!</td><td>(</td><td>)</td><td>[</td><td>]</td><td><</td><td>></td><td>=</td><td>+</td><td>-</td><td></td><td></td><td></td><td></td><td></td><td></td><td></td><td></td><td></td><td></td><td></td><td></td><td></td><td></td><td></td> </tr> <tr> <td>*</td><td>/</td><td>\</td><td>_</td><td>~</td><td>^</td><td>'</td><td>:</td><td></td><td></td><td></td><td></td><td></td><td></td><td></td><td></td><td></td><td></td><td></td><td></td><td></td><td></td><td></td><td></td><td></td><td></td><td></td><td></td> </tr> <tr> <td colspan="13">Default Sample</td> <td></td><td></td><td></td><td></td><td></td> </tr> </table>					B	C	D	E	F	G	H	I	J	K	L	M	N	O	P	Q	R	S	T	U	V	W	X	Y	Z	a	b	c	d	e	f	g	h	i	j	k	l	m	n	o	p	q	r	s	t	u	v	w	x	y	z	À	Á	Â	Ã	Ä	Å	Ç	È	É	Ê	Ë	Ì	Í	Î	Ï	Ð	Ñ	Ò	Ó	Ô	Õ	Ö	×	÷	¸	¸	¸	ì	í	î	ï	ò	ó	ô	õ	ö	÷	¸	¸	¸	¸	¸	¸	¸	¸	¸	¸	¸	¸	¸	¸	¸	¸	¸	¸	0	1	2	3	4	5	6	7	8	9	%	#	\$																*	/	?	!	()	[]	<	>	=	+	-																*	/	\	_	~	^	'	:																					Default Sample																	
B	C	D	E	F	G	H	I	J	K	L	M																																																																																																																																																																																																									
N	O	P	Q	R	S	T	U	V	W	X	Y	Z																																																																																																																																																																																																								
a	b	c	d	e	f	g	h	i	j	k	l	m																																																																																																																																																																																																								
n	o	p	q	r	s	t	u	v	w	x	y	z																																																																																																																																																																																																								
À	Á	Â	Ã	Ä	Å	Ç	È	É	Ê	Ë	Ì	Í	Î	Ï	Ð	Ñ	Ò	Ó	Ô	Õ	Ö	×	÷	¸	¸	¸																																																																																																																																																																																										
ì	í	î	ï	ò	ó	ô	õ	ö	÷	¸	¸	¸	¸	¸	¸	¸	¸	¸	¸	¸	¸	¸	¸	¸	¸	¸	¸																																																																																																																																																																																									
0	1	2	3	4	5	6	7	8	9	%	#	\$																																																																																																																																																																																																								
*	/	?	!	()	[]	<	>	=	+	-																																																																																																																																																																																																								
*	/	\	_	~	^	'	:																																																																																																																																																																																																													
Default Sample																																																																																																																																																																																																																				
Accept	Escape	Delete Letter	Cursor Left	Cursor Right																																																																																																																																																																																																																

Sample Size

Option: 0.0010 to 100.0000 g

Sample Size						
Enter the sample size in current unit.						
<table border="1"> <tr> <td>0.2500</td> <td>g</td> </tr> </table>					0.2500	g
0.2500	g					
Low Limit: 0.0010 g High Limit: 100.0000 g						
Accept	Escape	Delete Digit				

External Solvent Size

Option: 0.0010 to 100.0000 g

External Solvent Size				
Enter the size of the solvent used to prepare the supernatant.				
40.0000 g				
Low Limit: 0.0010 g High Limit: 100.0000 g				
ACCEPT	Escape	Delete Digit		

External Solvent Concentration

Option: 1.0 to 1000000.0 ppm

External Solvent Concentration				
Enter the solvent concentration used to prepare the supernatant.				
100000.0 ppm				
Low Limit: 1.0 ppm High Limit: 1000000.0 ppm				
ACCEPT	Escape	Delete Digit		

Extracted Sample Size

Option: 0.0010 to 100.0000 g

Extracted Sample Size				
Enter the extracted sample size used to prepare the supernatant.				
1.0000 g				
Low Limit: 0.0010 g High Limit: 100.0000 g				
ACCEPT	Escape	Delete Digit		

4.5.9.1.3. EXTERNAL DISSOLUTION

Sample Parameters																
Select the option to be modified.																
<table border="1"> <tr> <td>Sample Determ.:</td> <td>External Dissolution</td> </tr> <tr> <td>Sample Name:</td> <td>Default Sample</td> </tr> <tr> <td>Sample Size:</td> <td>1.0000 g</td> </tr> <tr> <td>External Solvent Size:</td> <td>0.2500 g</td> </tr> <tr> <td>External Solvent Conc.:</td> <td>10.0000 mg/g</td> </tr> <tr> <td>Dissolved Sample Size:</td> <td>0.2500 g</td> </tr> </table>					Sample Determ.:	External Dissolution	Sample Name:	Default Sample	Sample Size:	1.0000 g	External Solvent Size:	0.2500 g	External Solvent Conc.:	10.0000 mg/g	Dissolved Sample Size:	0.2500 g
Sample Determ.:	External Dissolution															
Sample Name:	Default Sample															
Sample Size:	1.0000 g															
External Solvent Size:	0.2500 g															
External Solvent Conc.:	10.0000 mg/g															
Dissolved Sample Size:	0.2500 g															
Select	Escape															

Sample Name

Option: Up to 15 characters

Sample Name																																																																																																																																						
Select the highlighted letter by using the arrow keys then press <Enter>. Select the empty field for a space. Press <Accept> to save the sample name.																																																																																																																																						
<table border="0"> <tr><td>█</td><td>B</td><td>C</td><td>D</td><td>E</td><td>F</td><td>G</td><td>H</td><td>I</td><td>J</td><td>K</td><td>L</td><td>M</td></tr> <tr><td>N</td><td>O</td><td>P</td><td>Q</td><td>R</td><td>S</td><td>T</td><td>U</td><td>V</td><td>W</td><td>X</td><td>Y</td><td>Z</td></tr> <tr><td>a</td><td>b</td><td>c</td><td>d</td><td>e</td><td>f</td><td>g</td><td>h</td><td>i</td><td>j</td><td>k</td><td>l</td><td>m</td></tr> <tr><td>n</td><td>o</td><td>p</td><td>q</td><td>r</td><td>s</td><td>t</td><td>u</td><td>v</td><td>w</td><td>x</td><td>y</td><td>z</td></tr> <tr><td>A</td><td>A</td><td>A</td><td>A</td><td>C</td><td>E</td><td>E</td><td>E</td><td>I</td><td>I</td><td>R</td><td>O</td><td>O</td></tr> <tr><td>0</td><td>0</td><td>0</td><td>0</td><td>à</td><td>á</td><td>â</td><td>ã</td><td>ç</td><td>è</td><td>é</td><td>ê</td><td>ë</td></tr> <tr><td>i</td><td>í</td><td>ñ</td><td>ò</td><td>ó</td><td>ô</td><td>õ</td><td>ú</td><td>û</td><td>ü</td><td>ÿ</td><td>z</td><td>i</td></tr> <tr><td>0</td><td>1</td><td>2</td><td>3</td><td>4</td><td>5</td><td>6</td><td>7</td><td>8</td><td>9</td><td>÷</td><td>#</td><td>\$</td></tr> <tr><td>*</td><td>,</td><td>?</td><td>!</td><td>(</td><td>)</td><td>[</td><td>]</td><td><</td><td>></td><td>=</td><td>+</td><td>-</td></tr> <tr><td>*</td><td>/</td><td>\</td><td>_</td><td>~</td><td>^</td><td>'</td><td>:</td><td></td><td></td><td></td><td></td><td></td></tr> </table>					█	B	C	D	E	F	G	H	I	J	K	L	M	N	O	P	Q	R	S	T	U	V	W	X	Y	Z	a	b	c	d	e	f	g	h	i	j	k	l	m	n	o	p	q	r	s	t	u	v	w	x	y	z	A	A	A	A	C	E	E	E	I	I	R	O	O	0	0	0	0	à	á	â	ã	ç	è	é	ê	ë	i	í	ñ	ò	ó	ô	õ	ú	û	ü	ÿ	z	i	0	1	2	3	4	5	6	7	8	9	÷	#	\$	*	,	?	!	()	[]	<	>	=	+	-	*	/	\	_	~	^	'	:					
█	B	C	D	E	F	G	H	I	J	K	L	M																																																																																																																										
N	O	P	Q	R	S	T	U	V	W	X	Y	Z																																																																																																																										
a	b	c	d	e	f	g	h	i	j	k	l	m																																																																																																																										
n	o	p	q	r	s	t	u	v	w	x	y	z																																																																																																																										
A	A	A	A	C	E	E	E	I	I	R	O	O																																																																																																																										
0	0	0	0	à	á	â	ã	ç	è	é	ê	ë																																																																																																																										
i	í	ñ	ò	ó	ô	õ	ú	û	ü	ÿ	z	i																																																																																																																										
0	1	2	3	4	5	6	7	8	9	÷	#	\$																																																																																																																										
*	,	?	!	()	[]	<	>	=	+	-																																																																																																																										
*	/	\	_	~	^	'	:																																																																																																																															
█ Default Sample																																																																																																																																						
Accept	Escape	Delete Letter	Cursor Left	Cursor Right																																																																																																																																		

Sample Size

Option: 0.0010 to 100.0000 g

Sample Size				
Enter the sample size in current unit.				
<p style="text-align: center;">█ 0.2500 g</p>				
Low Limit: 0.0010 g				
High Limit: 100.0000 g				
Accept	Escape	Delete Digit		

External Solvent Size

Option: 0.0010 to 100.0000 g

External Solvent Size				
Enter the size of the solvent used to prepare the supernatant.				
40.0000 g				
Low Limit: 0.0010 g High Limit: 100.0000 g				
ACCEPT	Escape	Delete Digit		

External Solvent Concentration

Option: 0.0100 to 100.0000 %

External Solvent Concentration				
Enter the solvent concentration used to prepare the supernatant.				
0.0100 %				
Low Limit: 0.0100 % High Limit: 100.0000 %				
ACCEPT	Escape	Delete Digit		

Dissoluted Sample Size

Option: 0.0010 to 100.0000 g

Dissoluted Sample Size				
Enter the dissoluted sample size used to prepare the supernatant.				
1.0000 g				
Low Limit: 0.0010 g High Limit: 100.0000 g				
ACCEPT	Escape	Delete Digit		

4.5.10. CONTROL PARAMETERS

The user can access and edit the parameters related to the titration.

Control Parameters														
Select the option to be modified.														
<table border="1"> <tr> <td>Titration Speed:</td> <td>Auto</td> </tr> <tr> <td>Imposed Current:</td> <td>2 μA</td> </tr> <tr> <td>End Point Value:</td> <td>100.0 mV</td> </tr> <tr> <td>Generator Current Mode:</td> <td>Auto</td> </tr> <tr> <td>Signal Averaging:</td> <td>2 Readings</td> </tr> </table>					Titration Speed:	Auto	Imposed Current:	2 μ A	End Point Value:	100.0 mV	Generator Current Mode:	Auto	Signal Averaging:	2 Readings
Titration Speed:	Auto													
Imposed Current:	2 μ A													
End Point Value:	100.0 mV													
Generator Current Mode:	Auto													
Signal Averaging:	2 Readings													
Select	Escape													

4.5.10.1. TITRATION SPEED

Option: Slow, Normal, Fast, Auto

Titration Speed								
Select the titration speed.								
<table border="1"> <tr> <td>Slow</td> </tr> <tr> <td>Normal</td> </tr> <tr> <td>Fast</td> </tr> <tr> <td>Auto</td> </tr> </table>					Slow	Normal	Fast	Auto
Slow								
Normal								
Fast								
Auto								
Select	Escape							

4.5.10.2. IMPOSED CURRENT

Option: 1 μ A, 2 μ A, 5 μ A, 10 μ A

Use the Δ and ∇ keys to select the electrode polarization current from the predefined list.

Imposed Current								
Choose the imposed current value in μ A.								
<table border="1"> <tr> <td>1 μA</td> </tr> <tr> <td>2 μA</td> </tr> <tr> <td>5 μA</td> </tr> <tr> <td>10 μA</td> </tr> </table>					1 μ A	2 μ A	5 μ A	10 μ A
1 μ A								
2 μ A								
5 μ A								
10 μ A								
Select	Escape							

Note: Higher polarization currents will speed the contamination of the electrode and potentially degrade samples.

4.5.10.3. END POINT VALUE

Option: 5.0 to 600.0 mV

Use the numeric keypad to enter the mV value at which the titration endpoint has been reached. This value is also used to determine when the pre-titration is complete.

End Point Value				
Enter the potential value representing the end point of the titration.				
100.0 mV				
Low Limit: 5.0 mV High Limit: 600.0 mV				
Accept	Escape	Delete Digit		

4.5.11. TERMINATION PARAMETERS

This screen allows the user to set the control parameters related to titration termination.

Termination Parameters												
Select the option to be modified.												
<table border="1"> <tbody> <tr> <td>Maximum Duration:</td> <td>1200 sec</td> </tr> <tr> <td>Maximum Water Titrated:</td> <td>20.000 mg</td> </tr> <tr> <td>Termination Criterion:</td> <td>Relative Drift</td> </tr> <tr> <td>Relative Drift:</td> <td>5.0 µg/min</td> </tr> </tbody> </table>					Maximum Duration:	1200 sec	Maximum Water Titrated:	20.000 mg	Termination Criterion:	Relative Drift	Relative Drift:	5.0 µg/min
Maximum Duration:	1200 sec											
Maximum Water Titrated:	20.000 mg											
Termination Criterion:	Relative Drift											
Relative Drift:	5.0 µg/min											
Select	Escape											

4.5.11.1. MAXIMUM DURATION

Option: 10 to 3600 seconds

If the titration endpoint is not reached, the titration will be terminated after the maximum duration. The error message "Value Out of Range" will appear on the display.

Maximum Duration				
Enter the time period after the titration is automatically stopped.				
1200 seconds				
Low Limit: 10 seconds High Limit: 3600 seconds				
Accept	Escape	Delete Digit		

4.5.11.2. MAXIMUM WATER TITRATED

Option: 0.1 to 100.0 mg

The maximum water reacted during the titration must be set according to the analysis.

If the titration endpoint is not reached, the titration will be terminated after the maximum titrated water has been reacted. The error message "Limits Exceeded" will appear on the display.

Maximum Water Titrated				
Enter the maximum water amount to be titrated.				
20.000 mg				
Low Limit: 0.1 mg High Limit: 100.0 mg				
Accept	Escape	Delete Digit		

4.5.11.3. TERMINATION CRITERION

Option: mV End Point, Absolute Drift, Relative Drift

Termination Criterion							
Select titration termination criterion.							
<table border="1"> <tr> <td>mV End Point</td> </tr> <tr> <td>Absolute Drift</td> </tr> <tr> <td>Relative Drift</td> </tr> </table>					mV End Point	Absolute Drift	Relative Drift
mV End Point							
Absolute Drift							
Relative Drift							
Select	Escape						

mV End Point The titration is terminated when the potential remains below a set endpoint value for a specified period of time.

Absolute Drift The titration is terminated when the actual drift is less than the predefined absolute drift value.

Relative Drift The titration is terminated when the actual drift is less than the sum between the initial drift and the predefined relative drift.

4.5.11.4. END POINT STABILITY TIME

Option: 1 to 30 seconds

The potential must remain below the set endpoint value for the specified period of time.

End Point Stability Time						
Enter the time period necessary to validate the titration end point.						
<table border="1"> <tr> <td>4</td> <td>seconds</td> </tr> </table>					4	seconds
4	seconds					
Low Limit: 1 seconds						
High Limit: 30 seconds						
Accept	Escape	Delete Digit				

4.5.11.5. ABSOLUTE DRIFT

Option: 0.0 to 40.0 $\mu\text{g}/\text{min}$

Absolute Drift				
Enter the drift value to be used by the termination criterion.				
15.0 $\mu\text{g}/\text{min}$				
Low Limit: 0.0 $\mu\text{g}/\text{min}$ High Limit: 40.0 $\mu\text{g}/\text{min}$				
Accept	Escape	Delete Digit		

4.5.11.6. RELATIVE DRIFT

Option: 0.0 to 40.0 $\mu\text{g}/\text{min}$

Relative Drift				
Enter the drift value to be used by the termination criterion.				
15.0 $\mu\text{g}/\text{min}$				
Low Limit: 0.0 $\mu\text{g}/\text{min}$ High Limit: 40.0 $\mu\text{g}/\text{min}$				
Accept	Escape	Delete Digit		

4.5.12. RESULT UNIT

Option: %, ppm, mg/g, $\mu\text{g}/\text{g}$, mg, μg , mg/mL, $\mu\text{g}/\text{mL}$

Result Unit												
Select the unit for your results.												
<table border="1"> <tbody> <tr><td>%</td></tr> <tr><td>ppm</td></tr> <tr><td>mg/g</td></tr> <tr><td>$\mu\text{g}/\text{g}$</td></tr> <tr><td>mg</td></tr> <tr><td>μg</td></tr> <tr><td>mg/mL</td></tr> <tr><td>$\mu\text{g}/\text{mL}$</td></tr> </tbody> </table>					%	ppm	mg/g	$\mu\text{g}/\text{g}$	mg	μg	mg/mL	$\mu\text{g}/\text{mL}$
%												
ppm												
mg/g												
$\mu\text{g}/\text{g}$												
mg												
μg												
mg/mL												
$\mu\text{g}/\text{mL}$												
Select	Escape											

4.5.13. SIGNIFICANT FIGURES

Option: Two (XX), Three (XXX), Four (XXXX), Five (XXXXX)

This option allows you to set the format for displaying the final titration result.

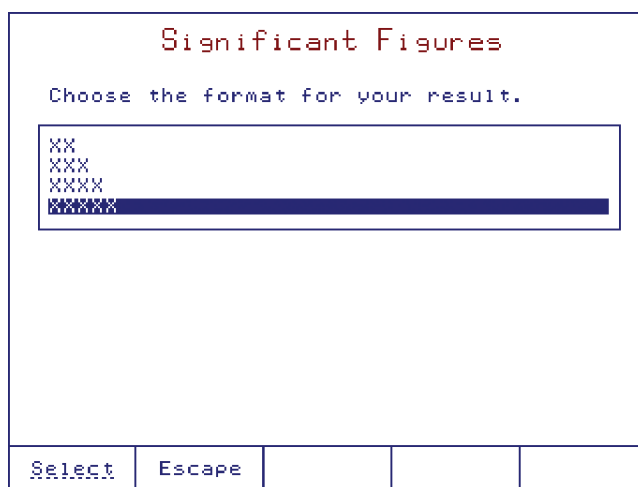

4.6. PRINTING

To print method parameters, press  from the main screen.

Press  and wait a few seconds until the printer completes the job.

If no printer is connected to the dedicated socket, or if the printer is offline, an error message will appear on the display (see [7.5. PERIPHERALS](#) section, for details on connecting a printer to the titrator).

5. TITRATION MODE

5.1. IDLE MODE

The titrator first enters **Idle** mode when it is switched on. All of the **HI934**'s software features and settings can be accessed from the **Idle** mode. This includes all of the user-adjustable method parameters, reagent handling system, file transfers, calibration checks, software upgrades, options for interface with PC and accessories.

Press  key to start **Pre-titration** mode.

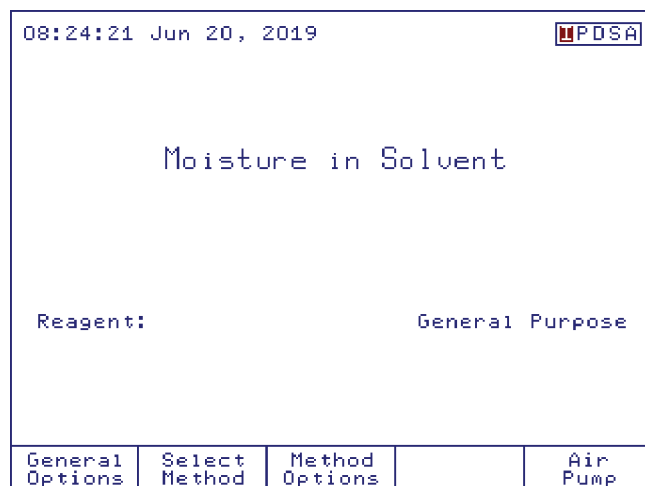

The titration is performed with the selected method.

Be sure that the selected method is customized in accordance with the specifics of the application.

Before performing a titration make sure that the following conditions are met:

- All of the attached systems are properly assembled.
- The right amount of reagent is present in the beaker (between the min and max marks) for best reproducibility.

The following intermediary stages are performed automatically before starting the titration:

- **Reagent pre-titration**
- **Drift analysis** (Automatic Determination Entry only)

When the drift analysis is finished, the titrator enters **Standby** mode and a titration can be started.

5.2. PRE-TITRATION

In pre-titration, the residual water on the interior surface of the titration vessel, the water contained in the entrapped air and the small amount of water from the reagent is eliminated.

The HI934 generates iodine electrolytically inside the titration vessel to react with the residual water. After the electrode potential has stabilized, the titrator moves into the **Drift Analysis**.

When the pre-titration is started, the stirrer is automatically turned on and the user cannot change the selected method or access the method parameters.

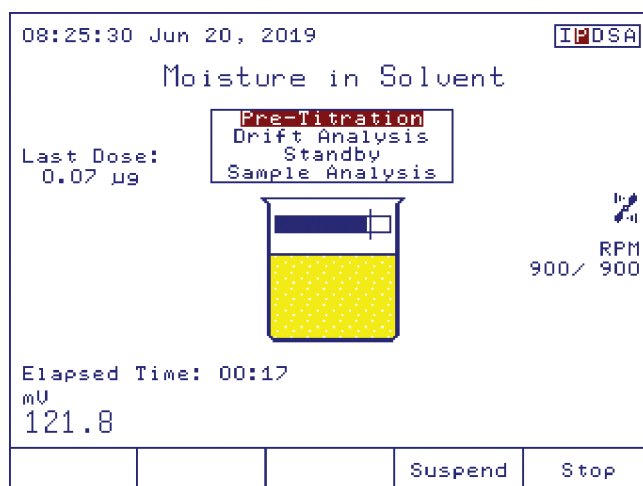

Note: If the pre-titration lasts longer than 30 minutes the titrator switches to **Idle** mode, errors may have occurred in your titration system (beaker is not properly sealed, wrong or missing reagent, disconnected or faulty electrode, etc.). Check the system and start the pre-titration again.

5.3. DRIFT ANALYSIS (AUTOMATIC DETERMINATION ENTRY ONLY)

In **Drift Analysis** the HI934 conducts a one minute analysis which determines the amount of moisture leaking into the cell from the atmosphere. Despite the titration vessel being tightly sealed, water will still seep into the cell. The amount of water that migrates into the cell per unit time is known as the background drift rate, or the drift rate.

The drift rate is determined by keeping track of the number of very small, successive doses of titrant required to maintain the 'dryness' of the reagent over the course of a minute. The rate at which water leaks into the cell is then calculated and reported by the HI934 in units of µg/min.

The HI934 will automatically subtract the drift rate from the titration results. This is important for titration accuracy when analyzing samples with very low water content, where the amount of water that has leaked into the cell is a considerable fraction of the total water titrated during the analysis.

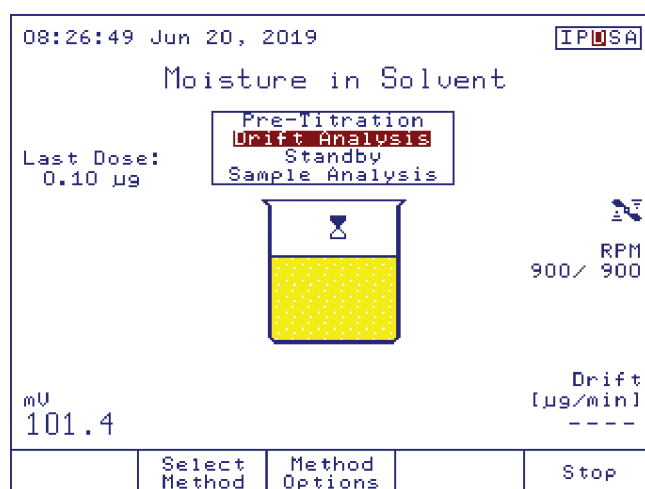

When the drift becomes stable the titrator switches to **Standby** mode.

During the drift analysis, if the titrator cannot maintain cell dryness, it reverts to pre-titration.

Note: If the drift entry mode is set as Manual Entry, the drift analysis stage is skipped.

5.4. STANDBY

After the drift rate has been determined, the HI934 enters **Standby**. In **Standby** the dryness of the titration vessel is maintained and the drift rate is continuously monitored and updated.

From **Standby** a sample analysis or drift rate logging session can be started as well as method selection, customization of method parameters and general options (by pressing <<Home>> on an external keyboard).

After an initial titrator setup and prior to the first titration, the drift rate should be allowed to settle in **Standby** for 45 minutes. This ensures that the drift rate is stable and reflects the actual rate at which water vapor is entering the cell, rather than representing a slow drying of the air between the reagent and the top of the cell. The stabilization can be verified by examining the drift rate vs. time curve.

During **Standby**, if the drift becomes unstable, the titrator will switch back to **Drift Analysis**.

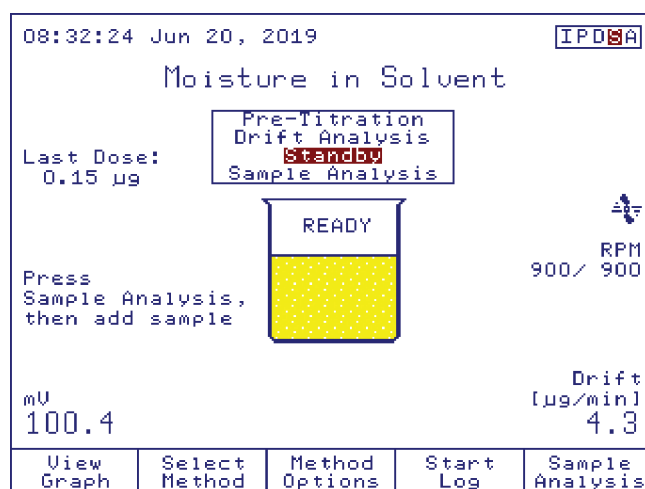

5.5. SAMPLE ANALYSIS

While in **Standby**, press  to start a titration.

Note: If the drift value is zero, a warning message appears to inform the user that the reagent may be overtitrated.

The user can choose to continue the titration by pressing  or to return to **Standby** by pressing  in order to wait until the drift is stabilized at a higher value.

Add Sample				
Please add the sample and enter the sample size.				
Estimated Conc.	1.000	×		
Sample Size	0.2145	g		
Optimal Limits				
Low Limit:	0.15 g			
High Limit:	0.35 g			
Press <Start Analysis> to start the sample analysis.				
Start Analysis	Escape	Delete Digit	Next	Balance

If necessary, update the estimated concentration. This value is used to determine the pre-titration volume. The optimal limits will be updated based on this value.

Follow the steps below to add the sample to the titration vessel and determine the sample size.

5.5.1. SAMPLE SIZE

5.5.1.1. MANUAL ENTRY

- 1) Attach a long needle (approximately 6 in. for best control) to a syringe large enough to hold at least one complete sample. For volumetric addition use a precision-volume syringe.
- 2) Rinse the syringe and needle with sample several times by drawing in a small portion of sample, fully extending the plunger, shaking to coat the syringe interior and expelling the sample into a waste collection container. For samples with low water content (less than 200 ppm), the final syringe rinse should not include drawing in air — humidity in the air could significantly contaminate the sample.
- 3) Draw enough sample into the syringe for at least one titration.
- 4) Dry the outside of the needle with a lint free cloth or tissue.
- 5) For samples by mass, place the full syringe with needle on an analytical balance. Tare the balance (back-weighing technique).
- 6) Insert the needle through the septum in the sample port. Push the syringe through the septum until the end of the needle is approximately 1 cm from the surface of the reagent.
- 7) Steadily dispense the appropriate amount of sample, ensuring that the sample is introduced directly into the reagent and does not splash or spatter onto the walls of the titration vessel or electrodes.
- 8) Draw a small amount of air from inside the cell into the syringe to ensure that no sample drops remain on the tip of the needle.
- 9) Remove the syringe and needle from the septum taking care to not touch the needle to the solvent or other internal cell components
- 10) Calculate the mass of the sample added to the titration cell (subtract the mass of the syringe after the sample has been added from the mass of the syringe before sample addition).
- 11) Enter the calculated mass of the sample into the **HI934**

5.5.1.2. AUTOMATIC MASS ACQUISITION FROM ANALYTICAL BALANCE (SAMPLE SIZE BY MASS ONLY)

The sample size can be automatically acquired from the balance when connected to the titrator using the RS 232 interface.

Sample Weighing				
Balance: Default				
Initial Weight: 0.2302 g				
Final Weight: -----				
Put weighing boat on the balance.				
Press <Accept> to update weight.				
Accept	Escape		Balance Setup	

5.5.2. PROCEDURE

- 1) Place the syringe containing the sample on the balance.
- 2) Wait until the reading has stabilized and press .
- 3) Add the sample in the titrator vessel.
- 4) Place the empty syringe on the balance.

Sample Weighing				
Balance: Default				
Initial Weight: 0.2302 g				
Final Weight: 0.0157 g				
Put empty weighing boat on the balance.				
Press <Accept> to update weight.				
Accept	Escape		Balance Setup	

- 5) Wait for the reading to stabilize and press .

The titrator returns to the previous screen and the sample size is automatically updated.

Add Sample				
Please add the sample and enter the sample size.				
Estimated Conc.	1.000	✕		
Sample Size	0.2623	g		
Optimal Limits				
Low Limit:	0.15 g			
High Limit:	0.35 g			
Press <Start Analysis> to start the sample analysis.				
Start Analysis	Escape	Delete Digit	Next	

Press to begin the analysis.

Note: The user must make sure that the balance and the titrator are properly configured and the balance feature is enabled (see 3.7. SETUP BALANCE INTERFACE section).

5.5.3. SAMPLE ANALYSIS

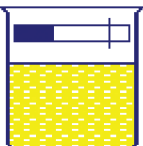
08:48:10 Jun 20, 2019		KF-00025	IPDS
Moisture in Solvent			
Last Dose: 1.49 µg		Pre-Titration Drift Analysis Standby Sample Analysis	
Titrated Water: 136.1 µg			
Initial Drift: 3.9 µg/min		RPM 900/ 900	
Elapsed Time: 01:09		Drift	
mU 429.5		[µg/min] ----	
Ln Progress		0.53821 mg/g	
View Graph		Suspend	Stop

Press the key to stop the titration and return to **Idle** mode.

Press to stop the titration and return to **Standby** mode.

5.5.4. SUSPEND TITRATION

While the titration is in progress, you can temporarily stop it by pressing . The generator will stop producing iodine.

To continue the titration, press .

5.5.5. VIEWING THE TITRATION CURVE

During a titration, the titration curve can be displayed on the **Titration Graph** screen, by pressing . The titration ID report is also displayed inside the graph window.

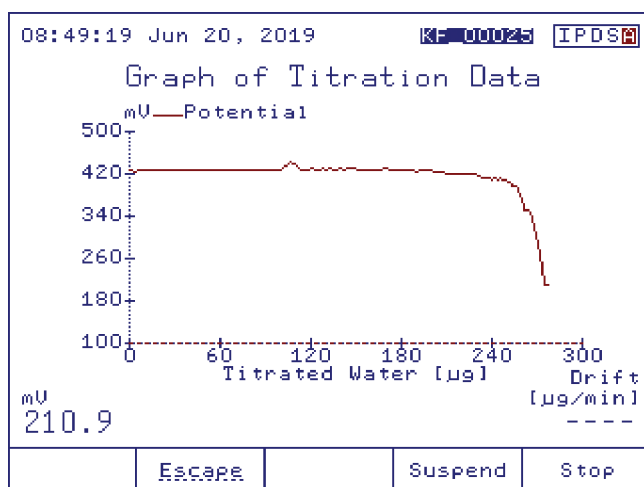

5.5.6. RESULTS

When the endpoint is reached, the titration is finished and the following screen is displayed.

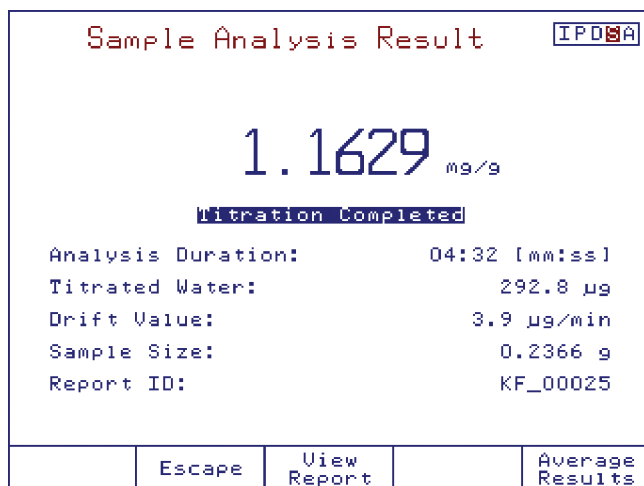

This screen displays information about the titration (duration, drift value used for compensation, sample size, titration report ID).

Press  to see the titration report.

Review Result			
KF_00025.RPT			
HI934 - Titration Report			
Method Name:	Moisture in Solvent		
Time & Date:	08:47 Jun 20, 2019		
Titration ID:	KF_00025		
Nr	Titration Water[μ g]	mV	Time
0	0.0	426.1	00:00:00
1	0.0	427.3	00:00:01
2	1.5	426.4	00:00:02
3	3.0	425.3	00:00:03
4	4.5	425.3	00:00:04
5	6.0	426.4	00:00:05
6	7.4	426.7	00:00:06

View Graph	ESCAPE	Print Report	Page Up	Page Down
------------	--------	--------------	---------	-----------

Press  to see the titration graph.

Press  to print the report.

5.5.7. SAMPLE ANALYSIS HISTORY

By pressing , the results will be added to the Sample Analysis History. Sample Analysis History can be used to obtain an average of the titration results.

Use the  and  keys to scroll the results list.

Use  to choose the samples that will be used for averaging.

Sample Analysis History	
Date/Time	Sample Conc.[mg/g]
* Jun 20, 2019 08:47	1.1629
* Jun 20, 2019 07:50	1.1601
* Jun 20, 2019 07:05	1.1598

Titrated Water:	292.8 μ g
Sample Size:	0.2366 g

Average Sample Conc.:	1.1609 mg/g
Standard Deviation:	0.00171 mg/g

Select	Escape			Delete
--------	--------	--	--	--------

Note: When there are no results selected, dashes will appear in the Average Sample Concentration and the Standard Deviation fields.

6. AUXILIARY FUNCTIONS

6.1. AIR PUMP

The air pump is used to add or remove the solvent in the titration vessel without exposure to atmospheric moisture.



To enter **Air Pump** screen, press  from the **Idle** screen.

6.1.1. FILLING THE BEAKER

To add solvent to the titration vessel:

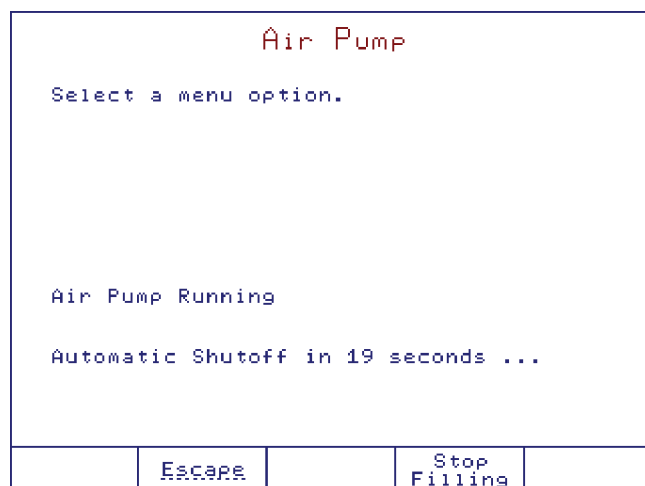
- 1) Press  from the **Air Pump** screen, the air pump will start and solvent will be added to the beaker. If the solvent is not flowing or is flowing very slowly, verify that the bottle top assemblies are properly assembled and tightly sealed and that the liquid handling tubing reaches the bottom of the solvent bottle.



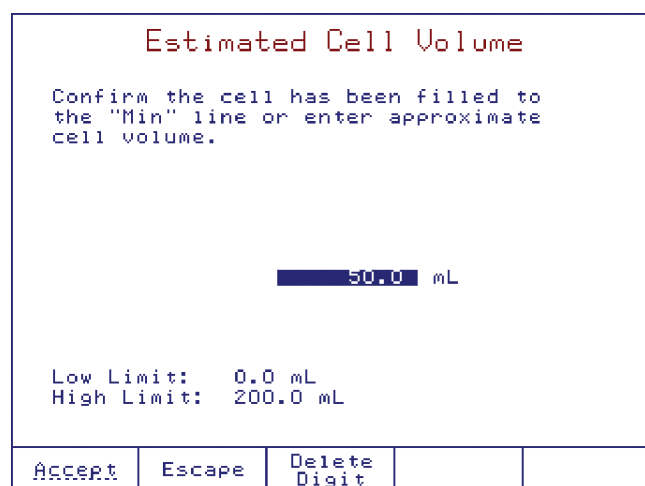

- 2) When the level of solvent inside the titration cell reaches the "Min" indicator line, press  to turn off the air pump. If  is not pressed, the air pump will automatically shut off after 20 seconds.
- 3) The **HI934** will prompt the user to verify that the titration cell has been filled to the "Min" line (approximately 75 mL). Press  to return to the **Idle** screen.



6.1.2. EMPTYING THE BEAKER



To remove the waste from the titration beaker:

- 1) Loosen the waste tube fitting slightly and slide the waste tube down until it reaches the bottom of the beaker.
- 2) From the **Air Pump** screen, press  and allow the air pump to run until all of the waste has been removed.
- 3) Press  to turn off the air pump. If  is not pressed, the air pump will automatically shut off after 60 seconds.
- 4) Return the waste tube back into its original position and replace the glass stopper.

6.2. STIRRER

Note: When custom stirrer is selected (see 3. GENERAL OPTIONS section), the commands related to the stirrer are not available.

In **Idle** mode the stirrer can be turned on and off by pressing the  key.

During the titration process, the stirring speed can be manually adjusted by using the  and  keys.

Note: The stirrer can not be turned off during the titration process.

6.3. RESULTS

To access the **Data Parameters** screen, press the  key.

From the **Data Parameters** screen you can access the following options:

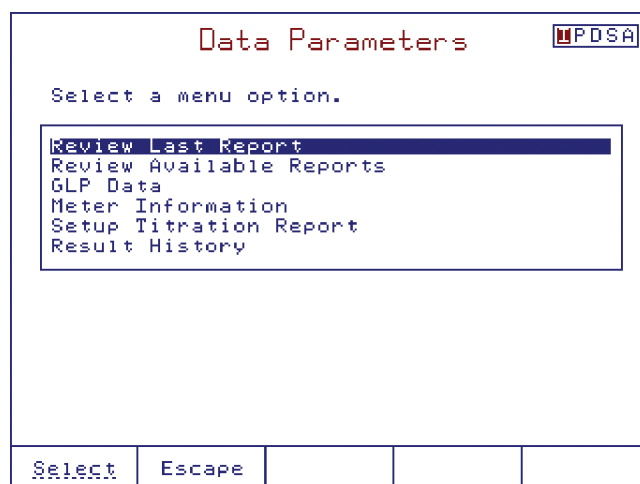

6.3.1. REVIEWING LAST REPORT

The last titration report can be reviewed.

Review Result				
KF_00099.RPT				
HI934 - Titration Report				
Method Name:	Moisture in Solvent			
Time & Date:	13:41 Feb 18, 2019			
Titration ID:	KF_00099			
Nr	Titration Water[μg]	mV	Time	
0	0.0	591.0	00:00:00	
1	0.0	591.3	00:00:01	
2	10.0	592.7	00:00:02	
3	20.0	592.3	00:00:03	
4	29.9	592.7	00:00:04	
5	39.8	592.4	00:00:05	

View Graph	ESCAPE	Print Report	Page Up	Page Down
------------	--------	--------------	---------	-----------

The information seen in the report is based on the selections made in the **Setup Titration Report** screen.

The following option keys are available:

View Graph	Review the titration graph.
Print Report	Print the titration report.
Escape	Return to the previous screen.
Page Up	Can be used to scroll through the pages.
Page Down	

6.3.2. REVIEWING AVAILABLE REPORTS

Up to 100 reports can be saved on the titrator. To view one of the saved reports highlight a report and then press

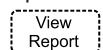

Available Reports				
Highlight a report & press <View Report> to see the detailed data.				
Moisture in Solvent	ID:KF_00099			
Titration Report	13:41 Feb 18, 2019			
Moisture in Solvent	ID:KF_00097			
Titration Report	12:29 Feb 18, 2019			
Moisture in Solvent	ID:KF_00098			
Titration Report	13:36 Feb 18, 2019			
Moisture in Solvent	ID:KF_00096			
Titration Report	12:18 Feb 18, 2019			
TEST 1mg/g	ID:KF_00095			
Titration Report	12:09 Feb 18, 2019			
TEST 1mg/g	ID:KF_00094			
Titration Report	11:57 Feb 18, 2019			
TEST 1mg/g	ID:KF_00093			
Titration Report	11:46 Feb 18, 2019			

View Graph	Escape	View Report	Print Report	Delete Report
------------	--------	-------------	--------------	---------------

The report contains only the information selected in the **Setup Titration Report** screens during report generation.

The following option keys are available:

View Graph	Review the selected graph.
View Report	Review the selected report.
Print Report	Print the selected report.
Delete Report	Delete the selected report.
Escape	Return to the previous screen.

6.3.3. GLP DATA

Option: Up to 20 characters

GLP Data																
Select a menu option.																
<table border="1"> <tr> <td>Company Name:</td> <td></td> </tr> <tr> <td>Operator Name:</td> <td></td> </tr> <tr> <td>Electrode Name:</td> <td></td> </tr> <tr> <td>Field 1:</td> <td></td> </tr> <tr> <td>Field 2:</td> <td></td> </tr> <tr> <td>Field 3:</td> <td></td> </tr> </table>					Company Name:		Operator Name:		Electrode Name:		Field 1:		Field 2:		Field 3:	
Company Name:																
Operator Name:																
Electrode Name:																
Field 1:																
Field 2:																
Field 3:																
Select	Escape															

Company Name Allows the company name to be recorded in each report.

Operator Name Allows the operator name to be recorded in each report.

Electrode Name Allows the electrode name to be recorded in each report.

Fields 1, 2, 3 Allows any additional information to be recorded in each report.

The fields must be selected from the **Setup Titration Report** screen (see [6.3. RESULTS](#) section) in order to be displayed in the titration report.

6.3.4. METER INFORMATION

Displays titrator configuration data.

Meter Information				
HI 934 Karl Fischer Coulometric Titrator				
SERIAL NUMBER				
Titrator Serial Number: 101490001111				
Analog Board Serial Number: 201510004111				
Stirrer Serial Number: 601110109111				
SOFTWARE VERSION				
Titrator Software Version: v1.00				
Base Board Software Version: v1.00				
Stirrer Software Version: v1.00				
Analog Calibration Date: Feb 15, 2019				
Generator Electrode Type: HI900511				
	Escape	Print		

Titrator Serial Number The serial number of the titrator base board.

Analog Board Serial Number The serial number of the titrator analog board.

Stirrer Serial Number The serial number of the stirrer.

Stirrer Software Version The current software version of the stirrer.

Titrator Software Version The current software version installed on the titrator.

Base Board Software Version The current software version on the base board of the titrator.

Analog Calibration Date Manufacturer calibration date of analog board.

Note: If more than 1 year elapsed from the calibration date of the analog board, the message **Analog Calibration Due** will appear on the main screen and analog board recalibration must be performed.

6.3.5. SETUP TITRATION REPORT

Customize a unique report to record the titration results. An asterisk means that it will be included in the titration report.

Set Up Titration Report

Select fields to be saved in the report.

- * Result and Units
- * Titration Method
- * Standard/Sample Size
- * End Point Volume
- * Titration Duration
- * Date and Time
- * Titration Ended By
- * All Data Points
- * **Method Parameters**
- Company Name
- Operator Name
- Electrode Name
- Field 1
- Field 2

Unselect	Escape	Save Report	Page Up	Page Down
----------	--------	-------------	---------	-----------

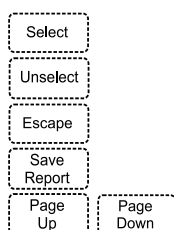

Adds the highlighted information to the report.

Removes the highlighted information from the report.

Returns to the **Data Parameter Screen**. Report is not updated.

Update the report with the select items. Report previously saved will not be updated.

Scroll through the options.

6.3.6. SAMPLE ANALYSIS HISTORY

This option allows the user to access the sample analysis history and average the titration results.

Use the  and  keys to scroll the results list.

Use  to choose the samples that will be used for averaging.

Sample Analysis History

Date/Time	Sample Conc. [mg/g]
* Jun 20, 2019 08:47	1.1629
* Jun 20, 2019 07:50	1.1601
* Jun 20, 2019 07:05	1.1598

Titrated Water:	292.8 µg
Sample Size:	0.2366 g

Average Sample Conc.:	1.1609 mg/g
Standard Deviation:	0.00171 mg/g

Select	Escape		Delete
--------	--------	--	--------

Note: When there are no results selected, dashes will appear in the Average Sample Concentration and the Standard Deviation fields.

7. MAINTENANCE & PERIPHERALS

7.1. GENERATOR ELECTRODE MAINTENANCE

Caution! Never heat generator electrodes over 50 °C when drying! This could cause permanent damage to the connector!

Generator electrodes should be cleaned every 1 to 2 weeks, more frequently if working with “dirty” or “oily” samples.

- 1) Remove the desiccant cartridge from the top of the generator and disconnect the cable. For generators with diaphragm, use the waste tube to remove the catholyte from the inner compartment.
- 2) Remove the generator from the titration vessel.
- 3) Rinse the inner and outer surfaces with dry methanol. DO NOT let any liquid / solvent get near the connector of the electrode!
- 4) For generators with diaphragm, place the generator in an empty titration vessel and fill the inner compartment with approximately 15 to 20 mL of dry methanol. Allow the methanol to diffuse through the diaphragm to clear contaminants. For a more thorough cleaning, repeat this procedure one to two more times.
- 5) Wipe joint grease off of the ground-glass joints with a clean, dry cloth or tissue.
- 6) Allow the generator to dry. Place in a drying oven (max 50 °C) for 1 hour, or until no liquid / condensation is visible. If an oven is not available use the generator immediately to avoid adsorption of moisture in the residual methanol.
- 7) If visible contamination remains, use an appropriate solvent to dissolve the contaminant. Soap and water may be used if needed, rinse with dry methanol and dry before use.

7.2. DETECTOR ELECTRODE MAINTENANCE

Proper detector maintenance is crucial for reliable measurements and extending the life of the detector. The frequency of maintenance will depend largely on the type of samples that are analyzed. Maintenance may be required if the electrode is slow or no response, noisy mV readings are observed, visible debris or coating on or between the electrode pins.

- 1) Remove the detector electrode from the titration vessel.
- 2) Rinse the electrode with a solvent that is appropriate for the type of sample used — methanol is usually sufficient.
- 3) Remove debris by gently wiping with a clean cloth or tissue. Allow the probe to dry completely.
- 4) If a more thorough cleaning is required, soak the electrode in **HI7061** Electrode Cleaning Solution for General Use, for several hours then rinse with water followed by methanol.
- 5) Allow the electrode to dry before use.
- 6) Inspect the glass for cracks, especially near the electrode pins. Replace the electrode if any cracks are found.

Note: *Cleaning the detector electrode with cleaning agents will remove platinum-iodine complexes that have formed on the electrode surface. This will lower the resistance of the detector and therefore lower the detector's mV readings. To counteract this change, lower the endpoint mV value, or raise the imposed current under Method Options. The platinum-iodine complex will reform after several titrations.*

Warning! *Take care to protect the electrode pins from damage! Avoid using brushes/ abrasives to clean the pins. Pins can easily bend, which will cause permanent errors in mV readings!*

7.3. REAGENT ADAPTER HOLDER MAINTENANCE

The glass tube of the reagent adapter holder can be removed for cleaning if reagent and/or waste has dripped into it. To clean the glass tube:

- 1) Remove the reagent exchange adapter from the top of the holder.
- 2) Slowly remove the glass tube. Use caution as hazardous reagent/waste may have accumulated inside the tube.
- 3) Rinse the tube with dry methanol. If needed, use soap and water, then rinse with methanol.
- 4) Wipe joint grease off of the ground-glass joints with a clean, dry cloth or tissue.
- 5) Dry the tube in a drying oven or thoroughly wipe dry.

7.4. REAGENT EXCHANGE ADAPTER MAINTENANCE

The reagent exchange adapter should be cleaned if excessive liquid and/or salts have built on the surfaces. Clean the adapter and holder if salts can be seen in or near the ground-glass joint. To clean the adapter:

- 1) Loosen the caps and remove the tubes from the adapter. Make sure that the bottled end of the tubes are not immersed in liquid to avoid spillage.
- 2) Remove the reagent exchange adapter from the top of the holder.
- 3) Disconnect the caps from their threads.
- 4) Rinse the adapter, o-rings, and caps (if necessary) with dry methanol. If needed, use soap and water, then rinse with methanol.
- 5) Wipe joint grease off of the ground-glass joints with a clean, dry cloth or tissue.
- 6) Dry the glass adapter in a drying oven or thoroughly wipe dry. Allow that caps and o-rings to air dry.
- 7) Ensure that all pieces are thoroughly dry before re-assembly.

7.5. PERIPHERALS

7.5.1. CONNECTING TO A PRINTER

A variety of parallel printers can be connected to the parallel port of the titrator using a DB25 cable.

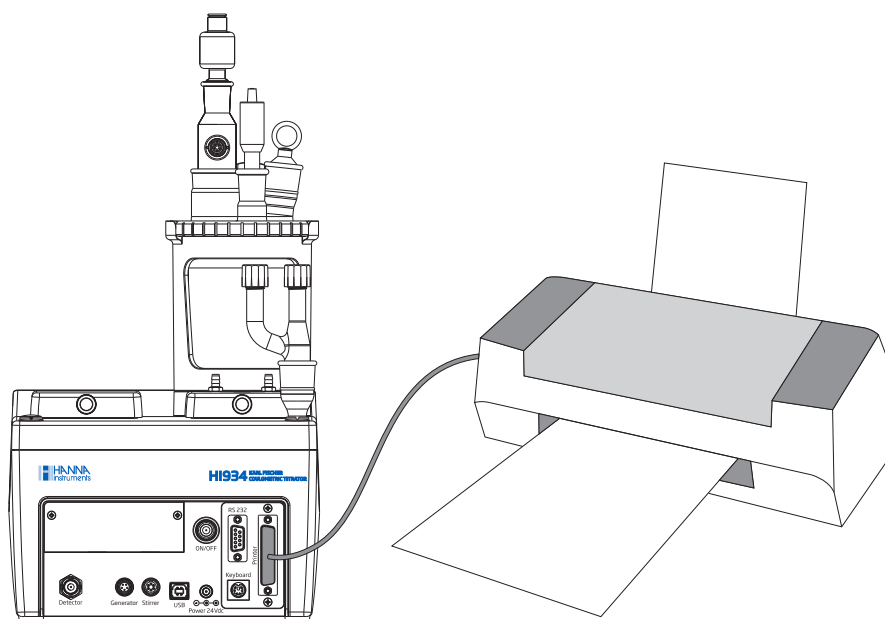

Warning! Connection/disconnection of POWER CORD, AIR PUMP/STIRRER, PRINTER or BALANCE must only be done when titrator and external devices are turned off.

7.5.2. CONNECTING TO A COMPUTER

The titrator can be connected to a computer using a USB cable. **HI900** PC application needs to be installed on the PC.

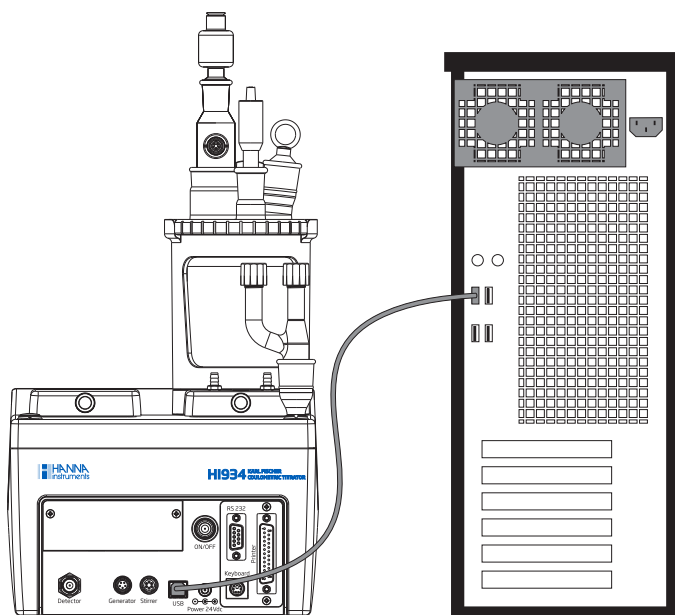

Connect the cable to the USB port on the rear panel of the titrator.

Connect the cable to the USB port on the PC.

Open the **USB Link with PC** screen on the titrator (see **3. GENERAL OPTIONS** section).

Launch the **HI900** PC application and then select the appropriate USB Port on the PC.

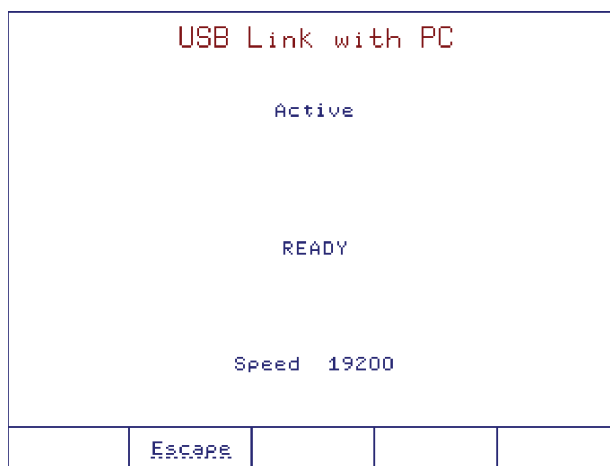

The **HI900** PC application allows the transfer of methods and reports between the titrator and PC.

Warning! Connection/disconnection of **POWER CORD**, **AIR PUMP/STIRRER**, **PRINTER** or **BALANCE** must only be done when titrator and external devices are turned off.

7.5.3. CONNECTING AN EXTERNAL PC KEYBOARD

This connection allows you to use an external PS/2 PC keyboard in addition to the titrator's keypad.

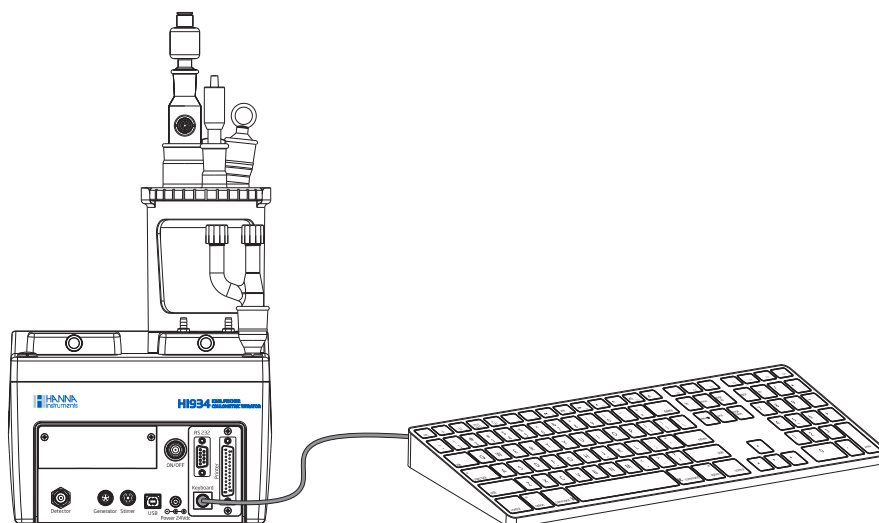

The correspondence between the titrator's keypad and the United States 101-type external keyboard can be found below:

External PC Keyboard (United States 101)	Titrator Keypad
Function Key F-1	?
Function Key F-2	stir
Function Key F-3	results
Function Key F-4	device
Function Key F-5	Option Key 1 (from left to right)
Function Key F-6	Option Key 2 (from left to right)
Function Key F-7	Option Key 3 (from left to right)
Function Key F-8	Option Key 4 (from left to right)
Function Key F-9	Option Key 5 (from left to right)
Function Key F-10	start stop
Arrow Key Up	▲
Arrow Key Down	▼
Arrow Key Left	◀
Arrow Key Right	▶
Page Up	Page Up
Page Down	Page Down
Numeric Keys: 0 to 9	0 to 9
Enter	enter
Alphanumeric Keys	Allow alphanumeric entries

8. METHOD OPTIMIZATION

8.1. TITRATION SETTINGS

The default settings included with standard methods have been developed by Hanna Instruments in order to provide accurate results for the majority of samples without requiring additional analyst input or method fine-tuning. However, in order to suit a wider variety of sample types and matrices, all of the **HI934** titration parameters are customizable. This section provides the descriptions of critical titration parameters necessary for an analyst to modify a standard method or develop a titration method from scratch.

HI934 methods can be modified and customized based on sample requirements, sample matrix and the reagent formulation. The user changeable settings are separated into two categories: Control Parameters, which set critical functions that determine the course of a titration and set the way in which titrations are terminated and Method Options, which control lesser features not directly affecting measurements and primarily allow advanced users to shorten titration times.

8.1.1. CONTROL PARAMETERS

8.1.1.1. ENDPOINT POTENTIAL & POLARIZATION CURRENT

The **HI934** uses a polarized electrode system known as bivoltametric indication. The titrator monitors the voltage required to maintain a constant polarization current (I_{pol}) between the dual platinum-pin Karl Fischer electrode during the course of a titration.

During a titration, no excess iodine is present. In order to maintain the set polarization current, the **HI934** must apply a relatively large voltage across the pins of the electrode.

At the endpoint of a titration, the amount of iodine added is equal to the amount of water from the sample. When an excess of iodine has been generated, iodine is present in the solution. The excess iodine is easily reduced and the resulting iodide is easily oxidized in electrode reactions at the cathode and anode respectively. The ease of these reactions makes maintaining the constant polarization current possible at a much lower electrode potential.

In theory, a large shift in the electrode potential indicates the endpoint. In practice, a titration endpoint is reached when the electrode potential drops below a predefined value and the chosen termination criteria is met.

The choice of endpoint potential should be based, foremost, on the polarization current and to a lesser extent, on the composition of the Karl Fischer solvent and the sample matrix. If the polarization current is changed, the endpoint potential must also be changed. In addition, there are pitfalls to be avoided when choosing an endpoint potential. Selecting endpoints which are both 'too high' or 'too low' will result in long titration times and poor reproducibility. Endpoints which are 'too high' are those which result in endpoints that either precede or coincide with equivalence point such that the concentration of excess iodine is not reliably detected. Endpoint potentials are considered 'too low' when they correspond to a large excess of iodine in the titration cell.

Note: *Cleaning the detector electrode with cleaning agents will remove platinum-iodine complexes that have formed on the electrode surface. This will lower the resistance of the detector and therefore lower the detector's mV readings. To counteract this change, lower the endpoint mV value, or raise the imposed current under Method Options. The platinum-iodine complex will reform after several titrations.*

8.1.1.2. TITRATION SPEED

The **HI934** predicts the approaching endpoint and reduces the volumes of titrant added until the endpoint is reached. This is a software controlled process known as dynamic dosing. Dynamic dosing prevents the addition of titrant beyond the endpoint and provides enhanced data density in the vicinity of the endpoint, resulting in accurate endpoint determination and faster titrations. The minimum and maximum dose volume must be set appropriately by the user for dynamic dosing to be effective.

The Titration Speed setting controls the rate of iodine generation. Faster titration speeds will reduce the titration time, but will increase the chance of over-titration. Slower titration speeds will allow greater endpoint accuracy, but will lengthen the titration time. The recommended titration speed for each sample depends on the amount of water introduced by the sample:

Titration Speed	Slow	Normal	Fast
Sample Moisture	< 300 μg	300 - 1000 μg	1000 μg

If Automatic is selected, the **HI934** will determine the appropriate titration speed based on the estimated water content and the amount of sample added to the vessel for each titration. If over-titration frequently occurs, select a slower titration speed. If a shorter titration duration is desired, select a faster titration speed.

8.1.1.3. SIGNAL AVERAGING

The chosen value for the signal averaging setting determines how many readings the electronics will average to produce a single data point on the titration curve. While higher values of 3, 4, up to 10 readings reduce electrode response time, they also result in a 'smoother' titration curve which may result in a faster titration (single unstable readings may cause the dose size to be reduced).

8.1.2. TERMINATION PARAMETERS

The **HI934** provides a choice of three criteria by which a titration can be considered to have successfully reached an endpoint.

8.1.2.1. STABILITY TIME

When this termination criteria is selected, a titration is considered to have reached an endpoint when the electrode potential stays below the specified endpoint potential for a period of time called the stability time. Typical endpoint stability times range between 5 and 15 seconds.

8.1.2.2. DRIFT STOP TERMINATION CRITERIA

Drift-based termination criteria, or Drift stop, terminates titrations based on the concept that at the end of a titration, when all of the water due to the sample has been reacted, the titrator should only be titrating the water seeping into the cell due to the background drift rate (see **5. TITRATION MODE** section for a detailed explanation of background drift). Ideally, drift stop termination criteria would end a titration when a drift rate identical to that which preceded the start of a titration is observed at the end of a titration. However, from a practical standpoint the achievement of an identical drift rate results in very long titration times.

In order to shorten titration times while still taking advantage of the positive aspects of drift-based termination, the **HI934** incorporates two drift stop termination criteria, relative drift stop and absolute drift stop.

8.1.2.2.1. RELATIVE DRIFT STOP

The relative drift stop termination parameter should be the first choice termination criteria. It is the most universally applicable, easiest to use and results in fast, repeatable titrations.

This parameter has the advantage over other termination criteria in that the relative drift rate termination value can be set independently from the titrant concentration and the initial drift rate.

Under this criteria a titration reaches an endpoint successfully when the **HI934** titrates all of the water introduced with the sample and maintains a drift rate which is equal to the sum of the initial drift (drift rate when the titration was initiated) and the set 'relative drift stop' value (i.e. a slightly higher drift than the initial drift rate).

The choice of relative drift stop value influences the titration duration and reproducibility. Choosing low relative drift stop values (3 to 5 $\mu\text{g}/\text{min}$) will result in titrations with high reproducibility and long durations. Setting high relative drift stop values (8 to 15 $\mu\text{g}/\text{min}$) will result in fast titrations with potentially reduced reproducibility.

Lower relative drift stop values are required for low-concentration samples. The last few micrograms of water from a sample are slow to react with iodine. Therefore, it is critical to allow the last few micrograms time to react since it may be a significant portion of the total titrated water. For titrations of less than 200 μg water, it is recommended to set the relative drift stop to 3 to 4 $\mu\text{g}/\text{min}$. Titrations of greater than 200 μg water can have a relative drift stop of 8 to 15 $\mu\text{g}/\text{min}$.

8.1.2.2.2. ABSOLUTE DRIFT STOP

Under this criteria, a titration reaches an endpoint successfully when the drift falls below a predefined threshold called the absolute drift stop value.

When setting the absolute drift threshold, a balance must be struck between the titration speed and accuracy. Choosing a threshold slightly higher than the initial drift rate will result in high reproducibility and relatively slow titrations. Setting the threshold higher ($> 30 \text{ mg}/\text{min}$) will result in very fast titrations and reduced titration reproducibility.

The current drift rate must be considered before selecting an absolute drift stop value. Setting to low of a value relative to the starting drift rate may cause the titration to continue indefinitely without reaching a valid endpoint.

8.1.3. METHOD OPTIONS

8.1.3.1. PRE-ANALYSIS STIR TIME

When analyzing samples with limited solubility or samples that release bound water slowly, the sample must be stirred in the chosen solvent prior to the start of a titration, to avoid erroneously low titration results or unreachable endpoints. The pre-analysis stir time option ensures that after the sample is added, the titration mixture is stirred for a period of time before any iodine is generated in the cell. The pre-analysis stir time can be set between 0 and 1000 seconds.

8.1.3.2. STIRRING SPEED

The **HI934**'s stirring speed can be set between 200 and 2000 RPM with 100 RPM resolution. The stirring system is equipped with an optical feedback mechanism to ensure that the stirring motor is rotating at the speed set by the user. The optimum stirring speed is obtained when a small vortex is visible. If the stirring speed is too low, the titrant will not react with the sample before reaching the electrode, resulting in over-titration and poor titration reproducibility. If the stirring speed is too high, bubbles will form in the solution. Bubbles can destabilize or falsify the measured electrode potential.

The default stirring speed for commercially available standard Karl Fischer reagents used within the operable volume range of the standard Hanna Instruments cell and with the supplied magnetic stirring bar is 900 RPM. Samples which result in a titration solution with higher or lower viscosity may require stir speed adjustment.

8.1.3.3. BACKGROUND DRIFT RATE ENTRY

This option provides a choice between the HI934's automatic drift rate determination and assigning a fixed value to be used by the titrator as the drift rate.

The primary benefit of bypassing the automatic drift rate feature is saving time. This is appropriate when titrating samples with high water content where the drift rate is too low to affect titration results or in diagnostic situations where there is no advantage in waiting for the HI934 to conduct a drift rate analysis.

8.2. THE SAMPLE

8.2.1. PROPER SAMPLING PROCEDURE

Proper sampling is essential for accurately determining the water content of bulk materials, particularly with non-homogeneous samples. Many standard methods detail instructions to ensure proper sampling. As a general rule, the following guidelines should be followed:

- The sample must be representative. The water content of the sample taken is the same as the average water content of the bulk material.
- Avoid exposing samples to the contaminating effects of atmospheric moisture. Take samples as quickly as possible and protect the sample during transport and/or storage.
- Take samples from the interior of bulk materials. Surfaces of hygroscopic materials may contain higher levels of moisture relative to the rest of the material. Surfaces of materials which release water may contain less water relative to the rest of the material.
- Taking large samples of bulk materials will result in a more representative sample.

8.2.2. DETERMINING THE OPTIMAL SAMPLE SIZE

The HI934 titrates optimally in the range of 0.5 to 2.0 mg water per sample. Ideally, the sample size would be scaled to always be in this range, but it becomes impractical to add the large sample sizes that would be required for concentrations of 500 ppm and lower. Attempting to add more than 10 g of sample increases the chance of erroneous results due to the sample significantly changing the composition of the reagent. In addition, the titration vessel will quickly fill after a couple of titrations if the sample size is 10 g. For samples below 500 ppm, the sample size should be a balance between titration accuracy (bigger sample size) and economy (less reagent waste). The following table shows the recommended sample size based on the moisture content:

Water Content	1 ppm	20 ppm	100 ppm	250 ppm	1000 ppm	1%	5%
Sample Size	10 g	5 g	3 g	2 g	1 g	0.1 g	0.02 g

8.2.3. SOLID SAMPLES

Solid samples should never be analyzed directly in the titration vessel. Solids greatly increase the risk of clogging the diaphragm of the generator, which could cause permanent damage. In addition, opening the titration vessel in order to add a solid sample would introduce a significant amount of moisture causing false high readings and increasing the drift between titrations. These samples should be analyzed by either external extraction or external dissolution.

8.2.4. LIQUID SAMPLES

The water contained in liquid samples must be available to react with the generated iodine. It is important to select a solvent system or mixture with which the sample is miscible.

Liquids are typically added through the septum in the sample port via a syringe and needle using the following steps:

- 1) Attach a long needle (approximately 6 in. long, 21-gauge) to a syringe large enough to hold at least one complete sample.
- 2) Rinse the syringe and needle with sample several times by drawing in a small portion of sample, fully extending the plunger, shaking to coat the syringe interior and expelling the sample into a waste collection container.
- 3) Draw enough sample into the syringe for at least one titration.
- 4) Dry the outside of the needle with a lint free cloth or tissue.
- 5) Determine the mass of the syringe and sample.
- 6) Initiate a titration from **Standby** mode by pressing the .
- 7) Insert the needle through the septum in the sample port. Push the syringe through the septum until the end of the needle is approximately 1 cm from the surface of the solvent.
- 8) Steadily dispense the contents of the syringe ensuring that the sample is introduced directly into the solvent and does not splash or spatter onto the wall of the titration vessel electrode or dispensing tip.
- 9) Draw a small amount of air from inside the cell into the syringe to ensure that no sample drops remain on the tip of the needle.
- 10) Remove the syringe and needle from the septum taking care to not touch the needle to the solvent or other internal cell components.
- 11) Calculate the mass of the sample added to the titration cell (subtract the mass of the syringe after the sample has been added from the mass of the syringe before sample addition).
- 12) Enter the calculated mass of the sample into the **HI934**.

When adding a liquid sample with a needle and syringe, it is important that the sample is introduced directly into the solvent. Sample that is deposited on the sides of the vessel or other internal components of the cell may not be titrated with the rest of the sample. It is equally important that no drops remain on the tip of the needle. "Hanging drops" will end up on the bottom of the septum. This will result in false low results for the determination.

Liquid samples with high viscosity, like honey, can be carefully warmed to improve the flow through the needle.

In some cases, liquid samples may require additional preparatory steps listed in the sections that follow. Specific sample preparation instructions are included with each standard method.

8.2.5. SAMPLE PREPARATION TECHNIQUES

While many samples can be introduced directly into the titration vessel (see **5.5. SAMPLE ANALYSIS** section), others require preparatory steps. It is critical that samples are not contaminated with additional water or lose water during the preparation phase.

The steps required for the most common sample preparation techniques are outlined below. For detailed application-specific instructions, consult the instructions included with applicable standard methods.

The **HI934** provides options for the automatic calculation of samples prepared normally, using external extraction and external dissolution.

8.2.5.1. DILUTIONS

It is very difficult to accurately add very small amounts of sample to the titration vessel. In order to produce accurate and reproducible results, samples having water content greater than 50 % should be diluted with a dry solvent before being introduced into the titration vessel. Dilutions are carried out using the 'external dissolution' sample type option. Anhydrous methanol is the solvent of choice for sample dilutions. If the sample contains fats or oils, then a mixture of methanol and chloroform can be used to promote solubility of the sample.

The following outlines a generic dilution procedure:

- 1) Determine the mass of a dry flask equipped with a septum stopper.
- 2) Transfer approximately 1 g of sample to the flask and measure the mass of the flask and the sample together.
- 3) Add 30 grams of dilution solvent to the flask. Re-seal and mix the flask contents.
- 4) Determine the moisture content of the dry solvent used as the diluent in a separate titration.
- 5) Use the prepared dilution for analysis.

8.2.5.2. EXTERNAL DISSOLUTION

External dissolutions are used for all solid samples or mixed-phase samples that will dissolve in a solvent mixture. Sample preparation and choice of solvent or solvent mixture is sample specific. Consult an applicable standard method for procedural details.

The **HI934** will conduct the necessary calculations automatically when 'external dissolution' is selected from the sample type menu.

8.2.5.3. EXTERNAL EXTRACTION

External extraction is used for all insoluble solid samples.

The **HI934** will conduct the necessary calculations automatically when 'external extraction' is selected from the sample type menu.

An outline of a general procedure follows:

- 1) Determine the mass of an extraction bottle or flask equipped with a septum.
- 2) Add the extraction solvent to the bottle and determine the mass of the bottle and the solvent. In order to maximize the effectiveness of the extraction, the water content of the solvent should be as low as possible. When choosing an extraction solvent, one must carefully consider the limit of water saturation for a possible solvent.
- 3) Determine the water content of the solvent.
- 4) Determine the mass of the solvent remaining in the extraction bottle.
- 5) Add a finely crushed sample to the solvent in the extraction bottle. The amount of sample added should be large enough so that the amount of water in the sample is much greater than that in the solvent before the extraction.
- 6) Facilitate extraction by shaking the solution or placing the solution on a stirring plate or in a sonicator.
- 7) Allow the insoluble portion of the sample to settle to the bottom of the extraction bottle.
- 8) Titrate an appropriately sized sample of the supernatant (solvent above the settled solid sample).

8.2.5.4. HOMOGENIZATION

Homogenization is recommended for non-aqueous or mixed phase liquid samples as well as solids with inhomogeneous distributions of water. Water can be evenly distributed throughout a collected sample by the use of high speed, high shear mixers called homogenizers.

In mixed phase (oil and water) non-aqueous samples, water tends to migrate to the surface of the sample solution, adhere to the inner walls or sink to the bottom of the sample bottle. This is particularly problematic when sampling is done at high temperatures and the specimen is subsequently allowed to cool to room temperature prior to analysis.

Solid samples typically exhibit inhomogeneous water distributions and must therefore be thoroughly reduced to powder or homogenized. The procedure for homogenization depends upon the characteristics of the specific sample.

Homogenization is particularly suited for semi-solid samples and suspensions and is the only method that can disrupt plant and tissue cells in order to release water present inside the cells. Homogenization is typically carried out externally in a dry flask with the addition of a suitable solvent, preferably methanol.

8.2.5.5. HEATING

Sample heating is used for the analysis of solid or liquid samples that cannot be extracted or that interfere with the Karl Fischer reaction. These include plastics, minerals, petrochemical products which contain additives, and starting materials for pharmaceutical products.

Samples are heated in a special oven while a dry stream of carrier gas passes through the sample chamber or, for liquid samples, the sample itself. The carrier gas is introduced into the titration vessel.

The heating temperature is sample specific and can be found in applicable standard methods. The temperatures are chosen to be as high as possible without decomposing the sample, which can result in contamination of the titration vessel.

8.3. KARL FISCHER REAGENT SYSTEM

A wide variety of Karl Fischer reagents exist on the market today, each designed and formulated for specific sample matrices and titration conditions.

Coulometric Karl Fischer reagent systems consist of an anolyte and a catholyte. Reagents for diaphragm-less generators are single-reagent systems. The reagent manufacturer will specify if a specific reagent is suitable for cells with diaphragm or without diaphragm (or both). For reagents requiring a diaphragm, the manufacturer will also supply a suitable catholyte.

Commercial reagents are typically formulated for one of the following applications:

- General Purpose
- Ethanol-based
- Ketone / Aldehyde
- Oil / Hydrocarbons

Consult a Standard Method or reagent manufacturer for appropriate reagents for an application.

8.3.1. WATER STANDARDS

Water standards are used to verify the titrator's performance and analyst technique. Water standards are an integral part of ISO 9000, GMP, GLP and FDA guidelines for water determination.

Water standards are available commercially in single-use sealed ampoules. Concentration values are typically 0.1, 1.0, and 10.0 mg/g and are certified by the manufacturer. Coulometry is an absolute method that does not require calibration or titer determination, but it is useful to occasionally titrate water standards as a system check. This will confirm that there are no issues with the method settings, reagents, sample addition technique, or the titrator electronics.

General procedure using a liquid water standard (ampoule):

- 1) Setup titrator according to the instruction manual. Ensure the titrator is set up with the same reagent, working conditions, temperature and titrator settings to be used for subsequent sample analyses.
- 2) Select an appropriate standard that closely matches the sample's water content.
- 3) Break open an ampoule of standard. Rinse a syringe with a small portion of standard.
- 4) Draw up the remainder of the standard into the syringe, weigh and titrate about one-third of the standard in the syringe.
- 5) Conduct two more titrations with the standard remaining in the syringe.
- 6) Review the set of results on the 'average results' statistics screen. The average standard concentration should be within the range specified on the Certificate of Analysis provided by the manufacturer. There should not be excessive variability between each result.

9. ACCESSORIES

9.1. ANOLYTE FOR CELLS WITH AND WITHOUT DIAPHRAGM

- Honeywell® HYDRANAL™ - Coulomat AG (Catalog Number 34836)
HYDRANAL™ - Coulomat E (Catalog Number 34726)
- GFS Chemicals® Watermark® - Vessel Solution, Pyridine-free (Catalog Number 1612)

9.2. ANOLYTE FOR CELLS WITH DIAPHRAGM

- Honeywell® HYDRANAL™ - Coulomat A (Catalog Number 34807)
HYDRANAL™ - Coulomat AG-H (Catalog Number 34843)
HYDRANAL™ - Coulomat AK (Catalog Number 34820)
HYDRANAL™ - Coulomat Oil (Catalog Number 34868)
- GFS Chemicals® Watermark® - Vessel Solution, CFC Free (Catalog Number 1607)
Watermark® - Vessel Solution, for Ketones and Aldehydes (Catalog Number 1619)
Watermark® - Vessel Solution, for Oils (Catalog Number 5202)
Watermark® - Vessel Solution, Pyridine-Based (Catalog Number 1622)
- JT Baker® HYDRA-POINT® - Vessel Solution, Pyridine-Free (Catalog Number 6280)
HYDRA-POINT® - Vessel Solution, CFC Free (Catalog Number 6284)
HYDRA-POINT® - Vessel Solution, for Ketones and Aldehydes (Catalog Number 6283)

9.3. ANOLYTE FOR CELLS WITHOUT DIAPHRAGM

- Honeywell® HYDRANAL™ - Coulomat AD (Catalog Number 34810)
- GFS Chemicals® Watermark® - Vessel Solution, Chloroform-Free (Catalog Number 1671)
- JT Baker® HYDRA-POINT® - Vessel Solution, Chloroform and Pyridine Free (Catalog Number 6285)

9.4. CATHOLYTE FOR CELLS WITH DIAPHRAGM

- Honeywell HYDRANAL™ - Coulomat CG (Catalog Number 34840)
HYDRANAL™ - Coulomat CG-K (Catalog Number 34821)
- GFS Chemicals® Watermark® - Generator Solution, Pyridine based (Catalog Number 1623)
Watermark® - Generator Solution, Pyridine-free (Catalog Number 1613)
Watermark® - Generator Solution, Universal (Catalog Number 2321)
- JT Baker® HYDRA-POINT® - Generator Solution, Pyridine-Free (Catalog Number 6281)
HYDRA-POINT® - Generator Solution, Universal (Catalog Number 6286)

9.5. WATER STANDARDS

- Honeywell® HYDRANAL™ - Water Standard 1.0 (Catalog Number 34828)
HYDRANAL™ - Water Standard 0.1 (Catalog Number 34847)

9.6. TITRATOR COMPONENTS

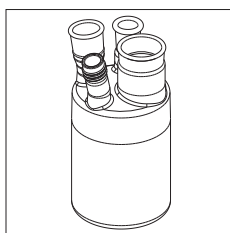

Titration Vessel (Glass Only)
HI900561

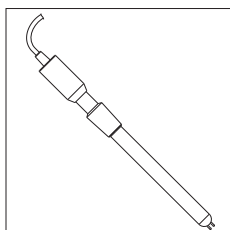

Detector Electrode
HI76330

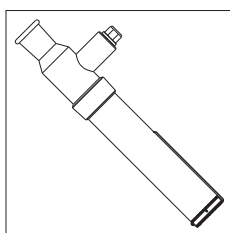

Generator Electrode with
Diaphragm
HI900511

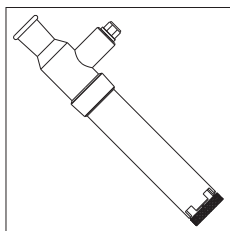

Generator Electrode without
Diaphragm
HI900512

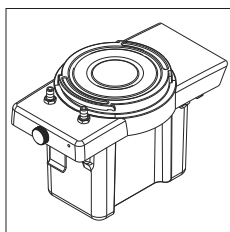

Air Pump and Magnetic
Stirrer for HI933/HI934
HI930180

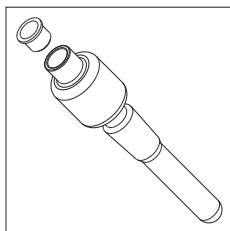

Desiccant Cartridge for
Generator Electrodes
HI900564

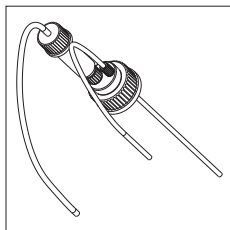

Bottle Top Assembly (with
molecular sieves)
HI900537

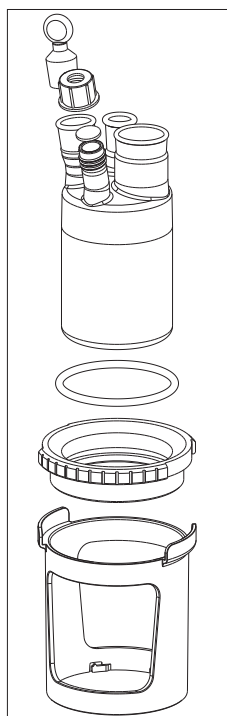

Titrator Vessel Assembly
HI930560

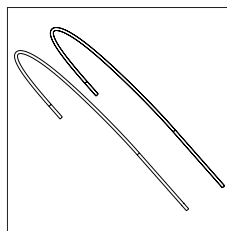

Tubing for Solvent/Waste
Handling (2 pcs.)
HI900535

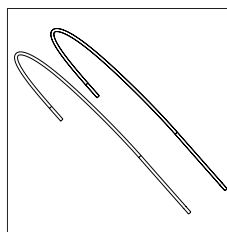

Tubing for Air Pump (2 pcs.)
HI900536

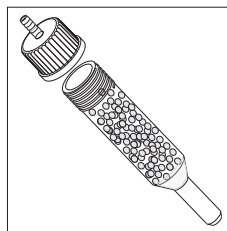

Desiccant Cartridge for Reagent/
Waste Bottles
HI900538

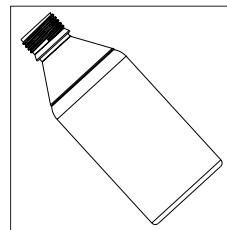

Waste Bottle
HI900534

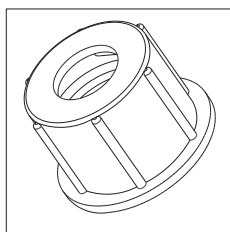

Open-top GL18 Cap
HI900566

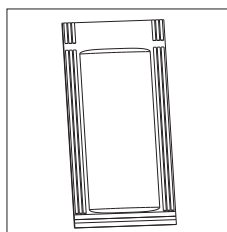

Glass Joint Grease
HI900543

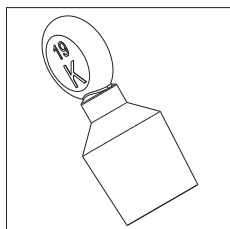

Glass Stopper, Standard
Taper 19
HI900563

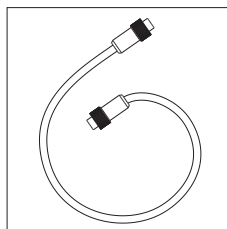

Generator Cable
HI900931

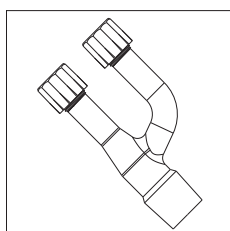

Reagent Exchange Adapter
HI900568

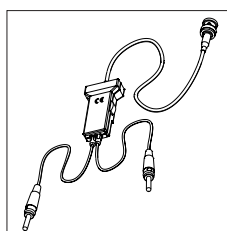

Calibration Key
HI900940

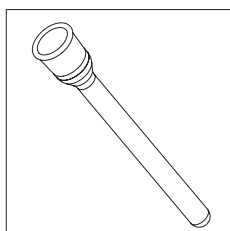

Reagent Adapter Holder
HI930182

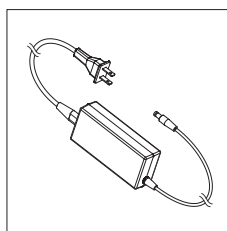

Power Adapter (USA Plug)
HI900946

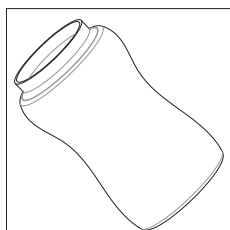

Molecular Sieves, 150 g
HI900551

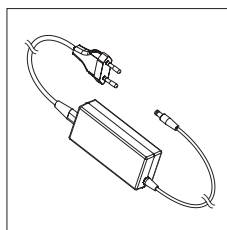

Power Adapter (European Plug)
HI900947

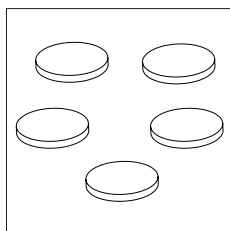

Septum (5 pcs.)
HI900567

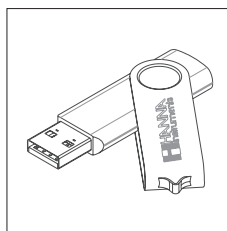

USB Flash Drive
HI930900U

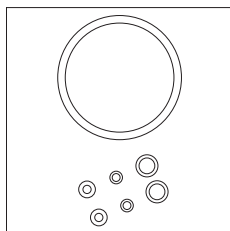

O-Ring Set
HI900542

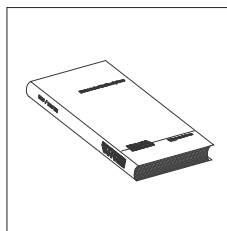

Instruction Manual Binder
HI930804

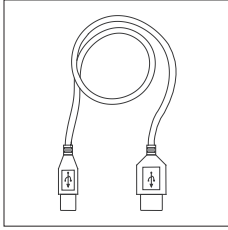

USB Cable
HI920013

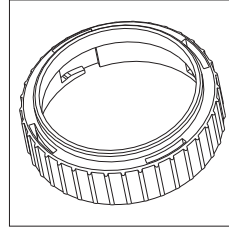

Beaker locker ring for HI933
HI930521

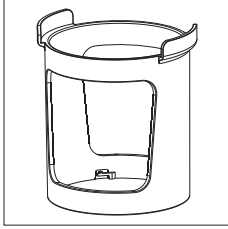

Beaker holder for HI933
HI930525

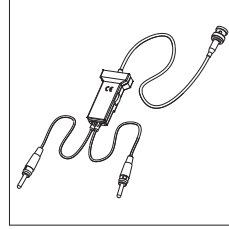

HI934 Generator Calibration
Cable
HI930939

PART 3:

APPLICATIONS



HI9001EN TITRATOR VALIDATION WITH 1.0 mg/g WATER STANDARD

DESCRIPTION

Method for the validation of the titrator accuracy. The results should be within the uncertainty limits specified by the manufacturer of the standard. The results are expressed in mg/g.

ELECTRODE

- HI76330 Dual Platinum Pin Electrode
- HI900517 Generator with Diaphragm
-or-
- HI900512 Generator without Diaphragm



REAGENTS

- General Purpose Coulometric Karl Fischer Reagent
- 1.0 mg/g Liquid Water Standard



ACCESSORIES

- 3 mL syringe (clean and dry)
- 22-gauge, 6" non-coring septum penetration needle (clean and dry)
- Solvent bottle, GL45 thread

DEVICE PREPARATION

- Connect the reagent bottle top assembly to the bottle of reagent according to the manual.
- Assemble the titration vessel according to the instruction manual.
- Press  from the main screen. Use the arrow keys to highlight *HI9001EN Validation - 1.0 mg/g Std* and press .
- Dispense enough reagent from the reagent bottle to fill the vessel to the "min" line (about 75 mL).
- Press  key to pre-titrate the reagent and the titration vessel moisture. Allow the background drift rate to stabilize before proceeding to the next step.

ANALYSIS

- Fill the syringe and needle with the standard. Any unused standard remaining in the ampoule should be disposed in order to avoid contamination from atmospheric water.
- Weigh the syringe, needle and standard.
- Press . You will be prompted to enter the sample size.
- Dispense 1.00 g (approximately 1 mL) of standard into the titration vessel through the septum using the needle.
- Pay attention not to get any standard on the electrode or beaker walls. If necessary, swirl the titration vessel gently by hand to remove any standard from the electrode or beaker wall.
- Clear the needle of residual standard by intaking a small volume of air from the titration vessel. If a "hanging drop" of standard is seen on the end of the needle, dip the end of the needle briefly in the reagent.
- Remove the needle from the titration vessel and weigh the syringe again in order to determine the added standard mass (by difference of the two measurements.)
- Use the numeric keypad to enter the exact weight and press  key to start the analysis.
- At the end of the titration, the **Sample Analysis Result** screen is displayed. The results are expressed in mg/g.

METHOD PARAMETERS

Name: Validation- 1.0mg/g Std
 Method Revision: 1.0
 Type: KF Coulometric
 Pre-Analysis Stir Time: 5 Sec
 Stirring Speed: 900 RPM
 Stirbar Type: Medium
 Drift Entry: Automatic
 Reagent: General Purpose
 Sample Parameters:
 Sample Determ.: Normal
 Sample Name: DefaultSample
 Sample Type: Mass
 Sample Size: 1.0000 g
 Control Parameters:
 Titration Speed: Auto
 Imposed Current: 2 uA
 End Point Value: 100.0 mV
 Generator Current Mode: Auto
 Signal Averaging: 2 Readings
 Termination Parameters:
 Maximum Duration: 1200 sec
 Maximum Water Titrated: 20.000 mg
 Term Criterion: Relative Drift
 Relative Drift: 5.0 µg/min
 Result Unit: mg/g
 Significant Figures: XXXXX

CALCULATIONS

Water titrated: H₂O (ug)
 Final Results Units: mg/g
 Sample mass: 1.0000 g

$$\text{mg/g} = \frac{\text{water } (\mu\text{g})}{1.0000 \text{ g}} \times \left(\frac{1 \text{ mg}}{1000 \mu\text{g}} \right)$$

RESULTS

Method Name: Validation- 1.0mg/g Std
 Time & Date: Apr 03, 2019 12:00
 Sample Size: 0.9412 g
 Drift Value: 0.8 ug/min
 Titrated Water: 950.02 ug
 Result: 1.0078 mg/g
 Titration Duration: 1:53 [mm:ss]
 Generator Electrode Type: HI900512
 Titration went to Completion
 Operator Name:
 Analyst Signature: _____

HI9301EN MOISTURE DETERMINATION IN SOLVENT

for external dissolution or extraction

DESCRIPTION

Method for the determination of moisture in extraction / dissolution solvent. Solvents should be less than 1.00 mg/g, substances with very low water content may require solvents with less than 0.100 mg/g. Results are expressed in **ppm**.

ELECTRODE

- HI76330 Dual Platinum Pin Electrode
- HI900517 Generator with Diaphragm
-or-
- HI900512 Generator without Diaphragm



REAGENTS

- General Purpose Coulometric Karl Fischer Reagent



ACCESSORIES

- 1 mL syringe (clean and dry)
- 22-gauge, 6" non-coring septum penetration needle (clean and dry)
- Solvent bottle, GL45 thread

DEVICE PREPARATION

- Connect the reagent bottle top assembly to the bottle of reagent according to the manual.
- Assemble the titration vessel according to the instruction manual.
- Press  from the main screen. Use the arrow keys to highlight *HI9301EN Moisture in Solvent* and press .
- Dispense enough methanol from the reagent bottle to fill the vessel to the "min" line (about 75 mL).
- Press  key to pre-titrate the solvent and the titration vessel moisture. Allow the background drift rate to stabilize before proceeding to the next step.

ANALYSIS

- Prepare an extraction / dissolution vessel with solvent and stir (see an applicable method for proper solvent amount and stirring time).
- Stop stirring the solvent in the extraction / dissolution bottle.
- Fill the syringe and needle with the extraction / dissolution solvent.
- Weigh the syringe, needle and solvent.
- Press . You will be prompted to enter the sample size.
- Dispense 1.00 g of solvent into the titration vessel through the septum using the needle.
- Pay attention not to get any sample on the electrode or beaker walls. If necessary swirl the titration vessel by hand to remove any solvent from the electrode or beaker wall.
- Clear the needle of residual sample by in taking a small volume of air from the titration vessel. If a "hanging drop" of solvent is seen on the end of the needle, dip the end of the needle briefly in the solvent.
- Remove the needle from the titration vessel and weigh the syringe again in order to determine the added sample mass (by difference of the two measurements.)
- Use the numeric keypad to enter the exact weight and press  key to start the analysis.
- At the end of the titration, the **Sample Analysis Result** screen is displayed. The results are expressed in **ppm** of water.

METHOD PARAMETERS

Name: Moisture in Solvent
 Method Revision: 1.0
 Type: KF Coulometric
 Pre-Analysis Stir Time: 5 Sec
 Stirring Speed: 900 RPM
 Stirbar Type: Medium
 Drift Entry: Automatic
 Reagent: General Purpose
 Sample Parameters:
 Sample Determ.: Normal
 Sample Name: DefaultSample
 Sample Type: Mass
 Sample Size: 0.3055 g
 Control Parameters:
 Titration Speed: Auto
 Imposed Current: 2 uA
 End Point Value: 100.0 mV
 Generator Current Mode: Auto
 Signal Averaging: 2 Readings
 Termination Parameters:
 Maximum Duration: 1200 sec
 Maximum Water Titrated: 10.000 mg
 Term Criterion: Relative Drift
 Relative Drift: 3.0 ug/min
 Result Unit: ppm
 Significant Figures: XXXXX

CALCULATIONS

Water titrated: H₂O (ug)
 Final Results Units: ppm
 Sample mass: 1.0000 g

$$\text{ppm} = \frac{\text{water } (\mu\text{g})}{1.0000 \text{ g}}$$

RESULTS

Method Name: Moisture in Solvent
 Time & Date: Apr 03, 2019 12:00
 Sample Size: 0.9165 g
 Drift Value: 5.2 ug/min
 Titrated Water: 213.45 ug
 Result: 598.31 ppm
 Titration Duration: 3:55 [mm:ss]
 Generator Electrode Type: HI900512
 Titration went to Completion
 Operator Name:
 Analyst Signature: _____

HI9901EN BROMINE INDEX OF AROMATIC HYDROCARBONS

Adaptation of ASTM D1492-08

DESCRIPTION

Method for the determination of bromine index of bromine-reactive substances. This method typically applies to aromatic hydrocarbons with only trace amounts of olefins (alkenes) and having bromine indexes less than 1000. For samples with a bromine index greater than 1000, it is recommended to dilute the sample with a suitable solvent. Results are expressed in **mg (Br)/100g**.

ELECTRODE

- HI76330 Dual Platinum Pin Electrode
- HI900517 Generator with Diaphragm
-or-
- HI900512 Generator without Diaphragm

REAGENTS

- Coulometric Bromine Index Reagent without Mercury

ACCESSORIES



- 1 mL syringe (clean and dry)
- 22-gauge, 6" non-coring septum penetration needle (clean and dry)
- Solvent bottle, GL45 thread

REAGENT PREPARATION



- Prepare 200 mL of 119 g/L potassium bromide solution, add 23.8 g of potassium bromide at a 200 mL volumetric flask, add roughly 125 mL of water, shake until dissolved and bring to volume with deionized or distilled water.
- To prepare 1 L of the reagent, add 600 mL of glacial acetic acid, 260 mL of methanol, 140 mL of 119 g/L potassium bromide solution to a 1 L volumetric flask. Bring to volume to deionized or distilled water. Transfer the solution to a reagent bottle.

DEVICE PREPARATION

- Connect the reagent bottle top assembly to the bottle of prepared reagent.
- Assemble the titration vessel according to the instruction manual.

- Press  from the main screen. Use the arrow keys to highlight *HI9901EN BrIndex of Aromatics* and press .
- Dispense enough reagent from the reagent bottle to fill the vessel to the "min" line (about 100 mL).
- Press  key to pre-titrate the solvent and the titration vessel moisture. Allow the background drift rate to stabilize before proceeding to the next step.

ANALYSIS

- Fill and weigh the syringe and needle with the sample.
- Press . You will be prompted to enter the sample size.
- Enter the Estimated Bromine Index. The titrator will recommend the optimal sample size to be added to the titration vessel. Dispense the amount provided from the optimal sample size into the titration vessel through the septum using the needle. Pay attention not to get any sample on the electrode or vessel walls. If necessary swirl the titration vessel by and to remove any standard on the electrode or beaker wall.
- Clear the needle of residual sample by in taking a small volume of air from the titration vessel. If a "hanging drop" of sample is seen on the end of the needle, dip the end of the needle briefly in the solvent.
- Remove the needle from the titration vessel and weigh the syringe again in order to determine the added sample mass (by difference of the two measurements.)
- Use the numeric keypad to enter the exact weight and press  key to start the analysis.
- At the end of the titration, the **Sample Analysis Result** screen is displayed. The results are expressed in **mg (Br)/100g**.

METHOD PARAMETERS

Name: BrIndex of Aromatics
 Method Revision: 1.0
 Type: Bromine Index
 Pre-Analysis Stir Time: 30 Sec
 Stirring Speed: 1600 RPM
 Stirbar Type: Medium
 Drift Entry: Automatic
 Reagent: BrIndex Reagent
 Sample Parameters:
 Sample Determ.: Normal
 Sample Name: DefaultSample
 Sample Type: Mass
 Sample Size: 0.5000 g
 Control Parameters:
 Titration Speed: Slow
 Imposed Current: 10 uA
 End Point Value: 300.0 mV
 Generator Current Mode: Auto
 Signal Averaging: 2 Readings
 Termination Parameters:
 Maximum Duration: 2400 sec
 Maximum Bromine Consumed: 25.0 mg
 Termination Criterion: mV End Point
 End Point Stability Time: 40 sec
 Result Unit: mg/100g
 Significant Figures: XXXXX

CALCULATIONS

Bromine Consumed: Br (mg)
 Final Results Units: mg/100g
 Sample mass: 1.0000 g

$$\text{mg/100 g} = \frac{\text{bromine (mg)}}{1.0000 \text{ g}} \times 100$$

RESULTS

Method Name: BrIndex of Aromatics
 Time & Date: Apr 03, 2019 12:00
 Sample Size: 0.4978 g
 Bromine Consumed: 1.609 mg
 Result: 323.33 mg/100g
 Titration Duration: 4:36 [mm:ss]
 Generator Electrode Type: HI900512
 Titration went to Completion
 Operator Name:
 Analyst Signature: _____



PART 4:

TITRATION THEORY



1. TITRATION THEORY

1.1. INTRODUCTION TO TITRATIONS

A titration is a quantitative, volumetric procedure used in analytical chemistry to determine the concentration of an analyte (the species being measured) in solution. The concentration of the analyte is determined by slowly adding a titrant (reagent) to the solution. As the titrant is added, a chemical reaction occurs between the titrant and the analyte. Titration reactions are relatively fast, simple reactions that can be expressed using a chemical equation. The titration reaction continues as the titrant is added until all of the analyte is consumed and the analyte reacts completely and quantitatively with the titrant.

The point at which all of the analyte has been reacted is called the equivalence point, also known as the theoretical or stoichiometric endpoint. This point is accompanied by an abrupt physical change in the solution, which sharply defines the endpoint of the reaction. The physical change associated with the titration endpoint can be produced by the titrant or an indicator and can be detected either visually or by some other physical measurement.

Titration cannot be used to determine the quantity of all analytes. The chemical reaction between the titrant and analyte must fulfill four requirements:

- The reaction must be fast and occur within approximately one second after the titrant has been added
- The reaction must go to completion
- The reaction must have well-known stoichiometry (reaction ratios)
- A convenient endpoint or inflection point

Titration is highly precise and can provide many advantages over alternative methods. Titrations are quickly performed and require relatively simple apparatus and instrumentation.

1.2. USES OF TITRATIONS

Titration can be used in many applications, including:

- Acid content of plant effluents, food (e.g. cheese and wine), plating and etching baths, petroleum products and pharmaceutical industry
- Base content of fertilizer (containing ammonia), bleach and minerals
- Hardness in water
- Metal content of alloys, minerals, ores, clays, waters, plating baths, paints, paper, plant materials, biological fluids and petroleum products
- Moisture content in foodstuff, petrochemicals, pharmaceutical products and plastics
- Redox reagent concentrations such as available chlorine in potable water, peroxide, traces of oxidants and reductants in food, reductants in high temperature or high pressure boiler water, vitamin analysis

1.3. ADVANTAGES & DISADVANTAGES OF TITRATIONS

Some advantages of titration as an analytical technique are:

- More precise results than many instrumental methods, such as measurement by electrode, the accuracy of the measurement is up to 0.1 %
- Simple methods, reasonable capital costs, and easy training
- Suitability to measure major components of a mixture or product
- Automation can reduce time and labor spent on each analysis

Some disadvantages of titration are:

- The time it takes to prepare standards and titrants
- Good technique is required to achieve precise results (training and practice required)
- Not suitable for determining trace or minor components of a mixture or product
- Limited dynamic range, it may require additional sample preparations (dilution) and repeat analyses

2. TYPES OF TITRATIONS

2.1. TITRATIONS ACCORDING TO THE MEASUREMENT METHOD

2.1.1. AMPEROMETRIC TITRATIONS

An amperometric titration is performed by placing two electrodes (often a metal ion selective electrode and a reference electrode) into the sample solution and keeping the potential of the metal electrode at a selected voltage. The current that flows, due to the oxidation or reduction of a reactant or product, is plotted vs. volume of titrant to provide the titration curve and locate the equivalence point. Changes in the current are due to changes in the concentration of a particular species (being oxidized or reduced at the electrode).

Generally the reaction between the analyte and titrant forms a new species. Depending on the titration, the reactants are electroactive and the products are not, or vice-versa. Amperometric titration curves look like two straight lines intersecting at the equivalence point, this is due to the change in the electroactivity of the solution.

Many metal ions can be amperometrically titrated using a precipitation, complexation or redox reaction. Some metal ions and species that can be determined in this manner include silver, barium, halides, potassium, magnesium, palladium, molybdate, sulfate, tungstate, zinc, bismuth, cadmium, fluoride, indium, thallium, iodine, and gold.

Figure 1 shows four amperometric titrations and their endpoints. In graph **A**, the analyte is electroactive and gives current but the reacted species does not. In **B**, the reactant is not active but the titrant is. In **C**, both the analyte and titrant are active and both give current flow. Graph **D**, shows the same situation as **B**; however, the current has an opposite sign (the titrant is reduced).

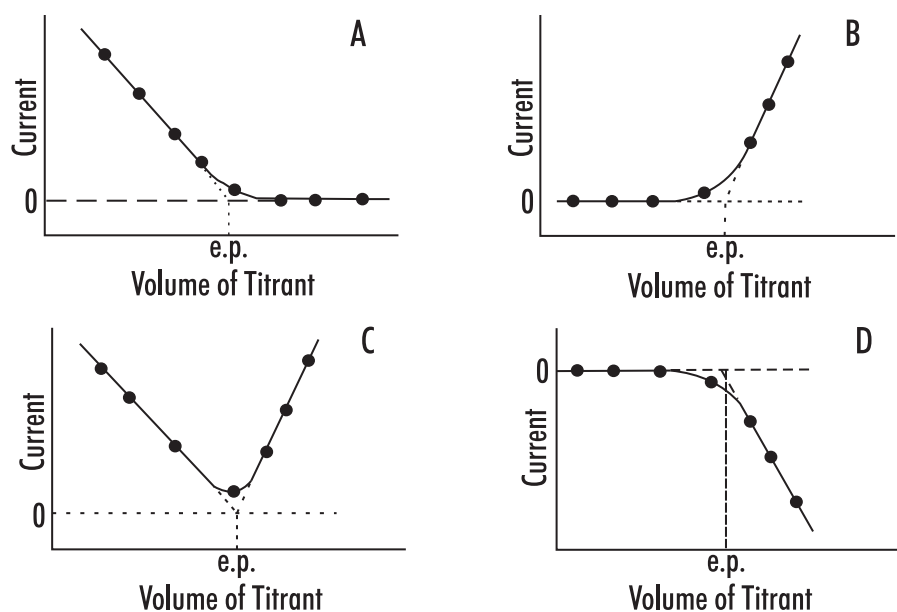

Figure 1

2.1.2. POTENTIOMETRIC TITRATIONS

Potentiometric titrations are done by measuring the voltage across the solution using an electrode system. An electrode system consists of an indicator electrode and a reference electrode. As titrant is added, the variations in the potential of the indicator electrode, with respect to the reference electrode, are monitored to show the progress of the titration.

Potentiometry is the measurement of a potential under conditions of zero current flow. The measured potential can then be used to determine the analytical quantity of interest, generally a component concentration of the analyte solution.

The potential that develops in the electrochemical cell is the result of the free energy change that would occur if the chemical phenomena were to proceed until the equilibrium condition has been satisfied.

There are many types of titrations where potentiometry can be used, e.g. pH electrodes for acid-base titrations, platinum ORP electrodes in redox titrations, ion selective electrodes, such as chloride or fluoride for a specific ion titration, and silver electrodes for argentometric (silver-based) titrations.

2.1.3. SPECTROPHOTOMETRIC TITRATIONS

The name comes from the method used to detect the endpoint of the titration, not its chemistry. Highly colored indicators that change color during the course of the titration are available for many titrations. More accurate data on the titration curve can be obtained if the light absorption is monitored instrumentally using a light source, a simple monochromator and a photodetector, rather than visually determining the color or light absorption change. Light absorption by either an indicator or by one of the reactants or products can be used to monitor the titration.

Figure 2, shows two titration curves. In graph **A** the absorption of a metal-indicator complex is being monitored. The absorption is constant while the metal is complexed by the EDTA titrant. The metal indicator complex was stripped, causing a sharp break in the titration curve. The point where all the metal is complexed and stripped from the indicator is the equivalence point. This point is marked by "e.p." on the graph.

In the second titration curve, graph **B**, the metal complex is being measured while being titrated with EDTA. The new complex being formed is not colored and does not absorb light. The extrapolated intersection of the two lines determines the equivalence point.

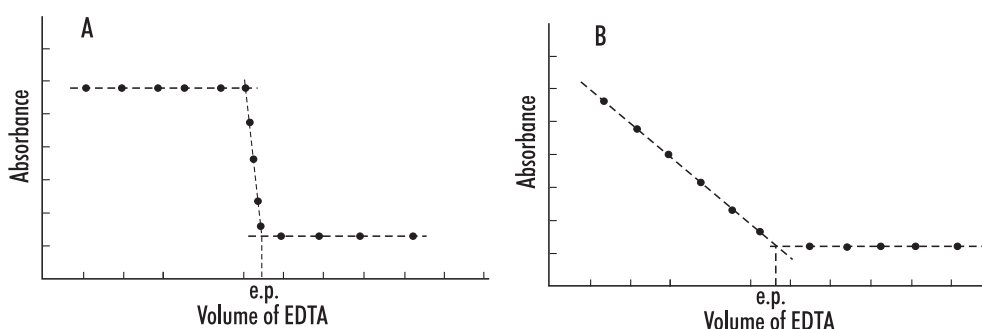

Figure 2

2.2. TITRATIONS ACCORDING TO THE REACTION TYPE

2.2.1. KARL FISCHER TITRATIONS

This method is based on a well-defined chemical reaction between water and the Karl Fischer reagent. The chemistry provides excellent specificity for water determination. The method can be used to determine free and bound water in a sample matrix. The Karl Fischer method is widely considered to produce the most rapid, accurate and reproducible results and has the largest detectable concentration range spanning 1 ppm to 100%.

The determination of water content is one of the most commonly practiced methods in laboratories around the world. Knowledge of water content is critical to understanding chemical and physical properties of materials and ascertaining product quality. Water content determination is conducted on many sample types including pharmaceuticals and cosmetics, foods and natural products, organic and inorganic compounds, chemicals, solvents and gases, petroleum and plastic products as well as paints and adhesives. The KF method is verifiable and can be fully documented. As a result, Karl Fischer titration is the standard method for analysis of water in a multitude of samples as specified by numerous organizations including the Association of Official Analytical Chemists, the United States and European Pharmacopoeia, ASTM, American Petroleum Institute, British Standards and DIN.

2.2.1.1. HISTORY OF KARL FISCHER TITRATIONS

Water determination by Karl Fischer titration is based on the reaction described by Bunsen in 1853 in which sulfur dioxide is oxidized by iodine in the presence of water.

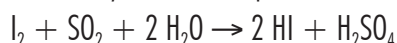

In Karl Fischer's 1935 article, "a new procedure for the titration of water", he presented a modified form of the Bunsen reaction adapted for use in determining the water content of non-aqueous solutions. His titrations were conducted in methanol in the presence of excess sulfur dioxide and pyridine in order to neutralize the acidic reaction products and drive the reaction to completion.



Two key developments have since lead to the currently accepted description of the Karl Fischer reaction. First, pyridine acts as a pH buffer and does not play a direct role in the reaction. This has allowed reagent formulators to replace pyridine with bases which are both less toxic and result in pH ranges that facilitate faster and more accurate titrations. Second, the species that reacts with water is not sulfur dioxide but the monomethyl sulfite ion resulting from the reaction between sulfur dioxide and methanol. Subsequently, researchers showed that higher alcohols can be used in place of methanol. The Karl Fischer reaction can therefore be described by the following generalized reaction sequence in which the H_2O , I_2 , SO_2 and RN species react in a 1:1:1:3 stoichiometry.

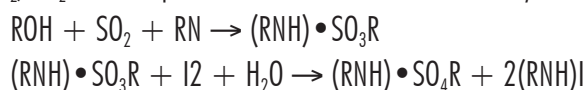

The maximum rate of the Karl Fischer reaction is reached between the pH range of 5.5 to 8 where all of the sulfur dioxide is available as methyl sulfite. If the pH drops below 5, the rate of reaction decreases and titration endpoint become increasingly difficult to reach. If the pH exceeds 8, side reactions begin to occur between iodine and hydroxide or methylate ions, changing the titration stoichiometry.

While solvents not containing alcohols can be used for Karl Fischer analysis, they also have an effect on reaction stoichiometry. When alcohols are not present, the reaction resembles the Bunsen reaction stoichiometry where the consumption ratio of water to iodine is 2:1. In solvents containing higher alcohols, uneven ratios can be observed due to the relative abilities of higher alcohols to form the sulfite ester that reacts with water. Issues resulting from solvent-induced variation in stoichiometry are not typically encountered during routine analysis for two reasons. First, titrant standardization and sample analysis are carried out in the same titration medium and under the same conditions, effectively compensating for any variation in reaction behavior. Second, most Karl Fischer reagent systems are formulated to support standard KF reaction stoichiometry.

2.2.1.2. VOLUMETRIC KARL FISCHER TITRATIONS

In volumetric Karl Fischer titrations, the iodine for the Karl Fischer reaction is introduced via the titrant. This method is suitable for higher water contents, 100 ppm to 100%. The other reaction components (sulfur dioxide, base, alcohol) can either be introduced by the titrant (one-component system) or by the solvent (two-component system). One-component reagent systems can utilize a custom solvent or solvent mixture since all of the Karl Fischer reaction components are in the titrant. However, one-component reagents are not very stable, they have a short shelf life and slower titration speeds. Two-component reagent systems are stable, have long shelf lives and faster titration speeds.

2.2.1.3. COULOMETRIC KARL FISCHER TITRATIONS

In coulometric Karl Fischer titrations, the iodine for the Karl Fischer reaction is generated electrolytically inside the titration vessel. This method is suitable for lower water contents, 1 ppm to 5%. The generator consists of two electrodes: an anode and a cathode. The reaction that occurs at each can be summarized as follows:

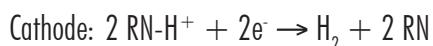
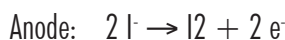

The iodine that is generated at the anode reacts with the water from the sample according to the Karl Fischer reaction. The amount of water that is reacted during a titration can be calculated based on the total charge that has passed through the generator. According to the Karl Fischer reaction (in protic solvents), 1 mole of water is titrated by 1 mole of iodine. According to the anodic reaction above, 1 mole of iodine is generated with 2 moles of electrons. Faraday's Constant states that 1 mole of electrons equates to 96485 coulombs (C) of electricity. Therefore, 96485 coulombs will cause 0.5 moles of water to be titrated, or 1 coulomb equals 93.36 μg of water:

$$1 \text{ C} \times \frac{1 \text{ mol e}^-}{96485 \text{ C}} \times \frac{1 \text{ mol I}_2}{2 \text{ mol e}^-} \times \frac{1 \text{ mol H}_2\text{O}}{1 \text{ mol I}_2} \times \frac{18.015 \text{ g H}_2\text{O}}{1 \text{ mol H}_2\text{O}} \times \frac{1000000 \mu\text{g}}{1 \text{ g}} = 93.36 \mu\text{g H}_2\text{O}$$

The amount of current that passes through the generator can easily and accurately be measured by the electronics of the titrator. Coulometric Karl Fischer titrations are considered absolute, standardization is not necessary. Water standards can be titrated as a system check to ensure proper system functioning.

2.2.1.3.1. GENERATOR ELECTRODES WITH DIAPHRAGM

The first coulometric Karl Fischer titrators used a diaphragm cell. In this design, the anode and cathode of the generator are separated by a diaphragm typically made of porous frit glass. The diaphragm prevents the iodine generated at the anode from being reduced at the cathode, this can cause false high water determinations. The anode compartment contains the Karl Fischer reaction components (sulfur dioxide, methanol, base) and iodide salts for the generation of molecular iodine. The cathode compartment contains a source of hydrogen ions, typically ammonium salts.

Diaphragm titrations have some disadvantages. The first disadvantage is the higher drift rates that occur due to moisture collecting inside the catholyte. Since the Karl Fischer reaction only occurs in the anode compartment, moisture inside the catholyte cannot be eliminated by pre-titration. Instead of being pre-titrated, the moisture inside that catholyte will slowly diffuse across the diaphragm during drift analysis and sample analysis, and will add to the apparent drift rate. The second disadvantage is the risk of diaphragm blockage or contamination. Substances in the sample matrix may clog the diaphragm, or salts could precipitate inside the diaphragm. A clogged diaphragm will prevent ion migration which, in severe cases, will block the electrolytic reaction of the generator. The third disadvantage is difficulty in cleaning. The diaphragm does not absorb or drain fluid quickly, making cleaning very time-consuming. The cathode compartment itself is also not very accessible for cleaning.

2.2.1.3.2. GENERATOR ELECTRODES WITHOUT DIAPHRAGM

To overcome the drawbacks of diaphragm titrations, diaphragm-less titration systems were made through modification of the generator's design and modification of the reagent. The cathode's surface is much smaller compared to the anode, allowing the generated iodine to react before possibly reaching the cathode. The reagent is also modified to prevent oxidizable sulfur compounds from forming.

Diaphragm-less titration offers very low drift rates and easy cell maintenance, but there are several drawbacks. First, side reactions are prone to occur particularly at slower titration rates. Therefore, samples with very low water contents may suffer from false high concentrations. Second, compounds that are easily reduced will react at the cathode and produce water, causing false high concentrations. These compounds include nitro compounds, unsaturated hydrocarbons, and certain metals.

2.2.1.4. VISUAL INDICATION OF KARL FISCHER TITRATIONS

Visual methods, originally used by Karl Fischer, are limited in application, require a high degree of skill and have been made obsolete by electrometric indication. For successful visual indication, titration samples must be colorless. Additionally, the solution coloration varies between polar and non-polar titration media.

After the titration equivalence point all of the water in the titration solution has been reacted. The next drop of titrant added to the solution after the equivalence point contains iodine that will remain in the titration solution. Thereafter, the concentration of iodine in the titration solution increases and the solution develops a yellow, and eventually brown, color. It is difficult, even for an experienced analyst, to generate reproducible endpoint coloration between successive titrations.

2.2.1.5. ELECTROMETRIC INDICATION OF KARL FISCHER TITRATIONS

Biamperometric and bivolametric indication are the two types of electrometric detection methods commonly used for indication of Karl Fischer titrations. Both methods use either a double platinum pin or a double platinum ring electrode to detect excess iodine in a titration solution. After the titration equivalence point, all of the water in the titration solution has been reacted. The next dose of titrant added to the solution contains iodine, which reacts at the electrode according to the reactions below.

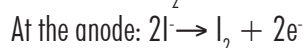
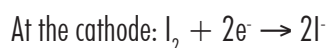

The excess iodine is easily reduced at the cathode, and the resulting iodide is oxidized at the anode.

Both electrometric methods of indication rely on electrons (current) being carried through a titration solution by the oxidation-reduction reactions described above. Biamperometric indication involves monitoring the flow of current through the titration solution while a constant voltage is applied across the platinum elements of the electrode. When water is present in the titration solution and there is no excess iodine, only minimal current flows between the electrode elements. After the equivalence point, when iodine is present, the current flow increases to a few μA .

Bivolametric indication involves measuring the voltage required to maintain a constant current flow between electrode elements. A small direct or alternating current called a polarization current (I_{pol}) is applied between the electrode pins or rings, and the resulting voltage is measured in order to monitor the titration progress.

L-shaped titration curves (figure 3) are generated for both methods by plotting either the electrode current or voltage against the volume of titrant added during the titration.

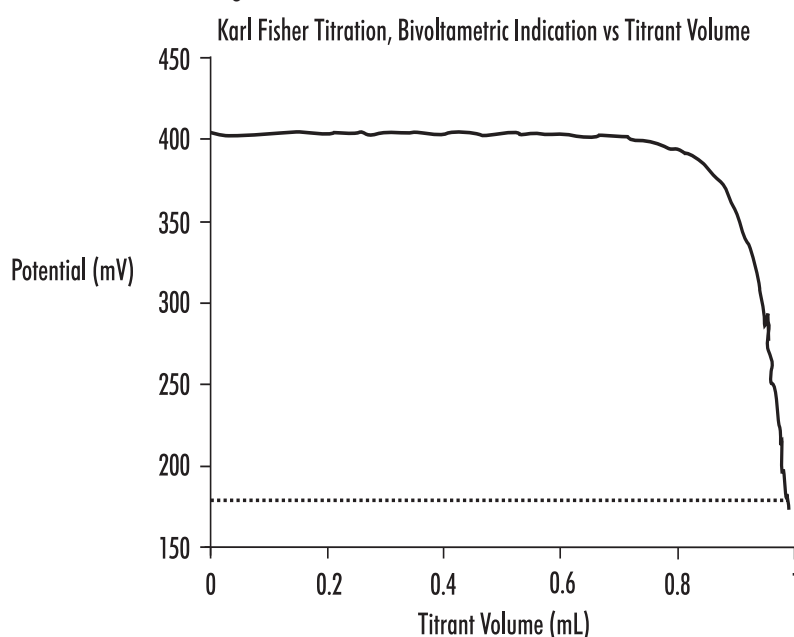

Figure 3

Electrometric methods result in over-titration or titration past the equivalence point where excess iodine is present in the titration solution. Titration past the equivalence point is acceptable for two reasons. First, due to the sensitivity of the electrometric methods, titrations are always carried out to the same, slight excess of iodine resulting in highly reproducible titrations. Second, the accuracy of electrometrically indicated titrations are not affected by the over-titration because the slight excess of iodine has been accounted for during the standardization of the titrant.

2.2.2. ACID-BASE TITRATIONS

Acid-base titrations are the most common type of titrations. Acid-base titrations are based upon a reaction between an acid and a base, a stoichiometric neutralization, or the exchange of protons. Virtually all acid-base titrations are carried out using a strong acid or a strong base as the titrant. The endpoint of a titration carried out with a weak acid or a weak base, would be difficult to detect due to a small change in pH at the equivalence point.

Chemical indicators are often used to determine the endpoint. The indicator will change color to signify that the end of the titration has been reached. When choosing the proper indicator you should select one that has a pK_a as close to the endpoint of the titration as possible. The color-change region of the indicator is usually ± 1 pH unit around the pK_a . The theoretical titration curve is useful for illustrating how the solution will change during the real titration, and allowing the proper selection of an endpoint or an indicator.

Figure 4 shows a traditional titration curve. The curve is obtained by plotting the pH value against the volume of NaOH added.

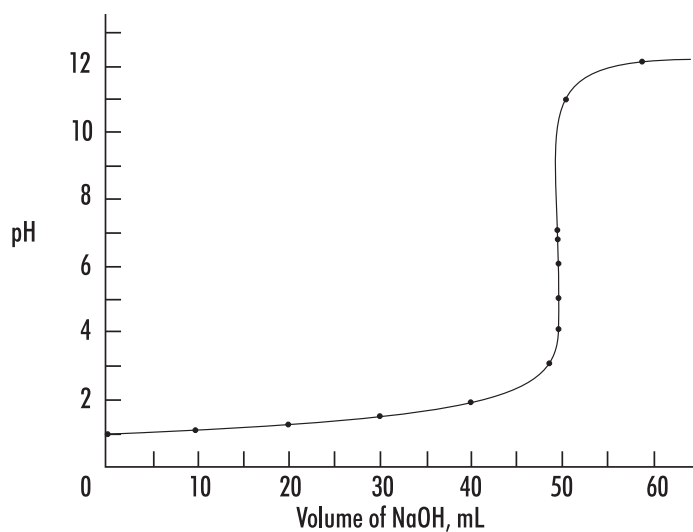

Figure 4

2.2.3. ARGENTOMETRIC TITRATIONS

Argentometric titrations use silver (nitrate) as the titrant and are generally precipitation titrations, as many silver salts are insoluble. These titrations are commonly used to titrate and determine the concentration of bromide, chloride, cyanide, iodide and sulfide.

Argentometric titrations can be done with Mohr's indicator. After all of the chloride has reacted, a red silver chromate precipitate is formed or the titration can be easily followed with a silver ISE (or chloride ISE for chloride titrations) and a reference electrode.

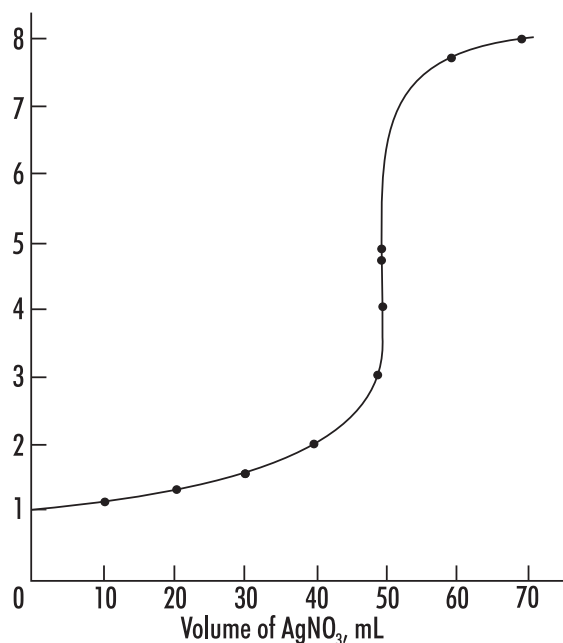

Figure 5

Figure 5 shows the titration of 50 mL of 0.1 N NaCl with 0.1 N AgNO₃. The potentiometric signal is from a chloride ISE, and is plotted as pCl ($-\log [\text{Cl}^-]$).

2.2.4. COMPLEXOMETRIC TITRATIONS

A complex is a species where a central metal ion is covalently bonded to one or more electron donating groups called ligands. In a complexometric titration, metal ions are titrated using a titrant that binds strongly to it. Often these titrants contain EDTA or CDTA, polydentate ligands that form very stable coordination compounds with metal ions. The complexation reaction must be fast in order to be useful for direct titration. Some metal ions react too slowly with EDTA for a direct titration.

An indicator electrode that responds to the metal ion can be used to monitor the titration progress. The titration curve will appear similar to a usual potentiometric titration. Complexation indicators change color at the endpoint as all metal ions are “consumed”, or complexed by the titrant.

The titration curve will appear similar to a potentiometric titration, when using an indicator electrode that responds to the metal ion (see Figure 6).

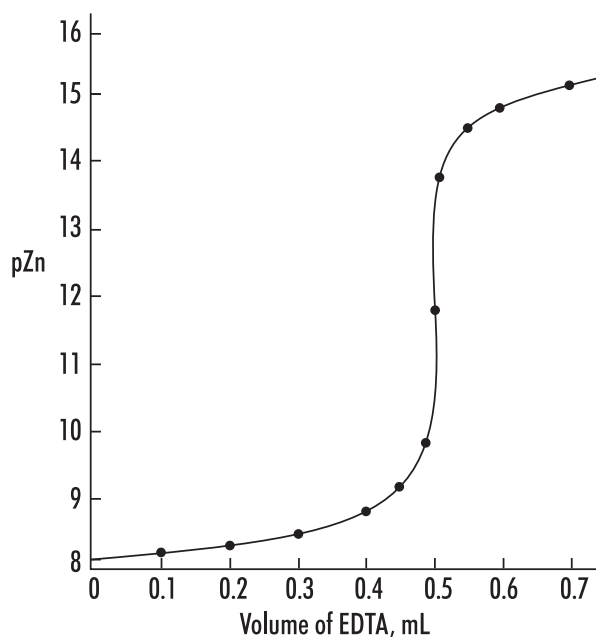

Figure 6

2.2.5. ION SELECTIVE TITRATIONS

The most popular ion selective titration is an acid-base titration. The hydrogen ion concentration is specifically measured and monitored during the titration process to locate the equivalence point. Using an ion selective electrode (ISE) as the indicator electrode, the potentiometric signal (in mV) is used to directly follow a specific ion's concentration (or activity). Examples of ISE titrations include titrating fluoride with an aluminum titrant using a fluoride ISE, chloride with silver nitrate using a chloride ISE, sodium with a sodium ISE, etc. The equivalence point can be determined by plotting the mV value vs. the amount of titrant added.

2.2.6. NON-AQUEOUS SOLVENT ACID-BASE TITRATIONS

Non-aqueous solvents must be used to titrate very weak acids and bases due to the inherent leveling effect water has on all acids and bases dissolved in it. A wide variety of weak acids and bases can be titrated using non-aqueous solvents. Mixtures of acids or bases can often be individually analyzed in a single sequential titration.

2.2.6.1. TITRATION OF ACIDS

Weak acids with pK_a 's up to about 11 can be titrated in non-aqueous solvents. These include carboxylic acids, enols, phenols, imides, sulfonic acids, and inorganic acids. Water or lower alcohols are suitable for titrating medium to strong acids (pK_a less than 5). Titrating a weaker acid with a strong base titrant requires a solvent less acidic than water or ethanol/methanol. Solvents such as acetone, acetonitrile, t-butyl alcohol, dimethylformamide, isopropanol and pyridine have been found to work well for acid-base titrations of strong, medium and weak acids/bases. Titrants include alcoholic potassium hydroxide and various sodium or potassium alkoxides in a 10:1 mixture of benzene/methanol. The best titrants are quaternary ammonium hydroxides (such as tetrabutylammonium hydroxide) due to good solubility of tetraalkylammonium salts of the titrated acids and the clean potentiometric titration curve obtained (see Figure 7)

2.2.6.2. TITRATION OF BASES

Weak bases with pK_b 's up to about 11, which do not ionize with water, can be titrated in non-aqueous solvents. These bases include aliphatic and aromatic amines, basic nitrogen heterocycles, alkali metal and amine salts of acids, and many other organic basic compounds. Titrating a weak base with a strong acid titrant requires a basic solvent that is as weak as possible. Water and alcohols allow the titration of medium strength bases such as aliphatic amines ($pK_b = 4$ to 5), but not the titration of weaker bases such as pyridine ($pK_b = 8.8$). Glacial acetic acid works well for weak bases and has been used extensively. Less basic solvents such as acetone, acetonitrile, and nitromethane extend the range of titratable compounds.

The endpoint for non-aqueous titrations are usually determined potentiometrically using a pH glass electrode, a modified calomel or double junction reference electrode with a low-flow rate reference junction. Good potentiometric titration curves are obtained in most solvents, except those with very low dielectric constants such as benzene, chloroform and others, when high electrical resistance of the solvent causes unstable potentials.

2.2.7. PRECIPITATION TITRATIONS

Precipitation titrations allow for faster analysis compared to the old gravimetric analysis, where a precipitate is formed, filtered, dried and weighed to analyze a compound. Typically silver halides, silver thiocyanate and a few mercury, lead, and zinc salts are titrated using this method. The chemical reactions must form an insoluble salt and precipitate out quickly in order to be analyzed using this method. When the reaction is not quick, a back titration can be used. A measured excess of the precipitating reagent (titrant) is added to force the reaction to occur, and then unreacted titrant is titrated with a standard solution of another reagent.

2.2.8. REDOX TITRATIONS

There are a number of oxidation-reduction reactions that can be used to determine unknown concentration by titration. If the reaction goes to completion, is fast and has an analytical signal available to follow it, a titration can be performed. The term “fast” means that each addition of titrant is reacted completely and the sensing electrode is able to detect the change in solution in less than one second (see Figure 8).

Redox titrations are potentiometric titrations where the mV signal from a combination ORP (redox) electrode (usually with a platinum indicator electrode) is used to follow the reaction of oxidant/reductant. The electrode potential is determined by the Nernst equation and is controlled by the oxidant/reductant ratio.

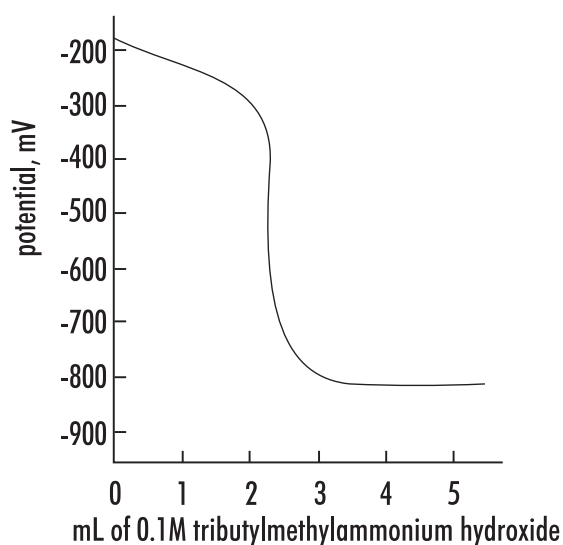

Figure 7

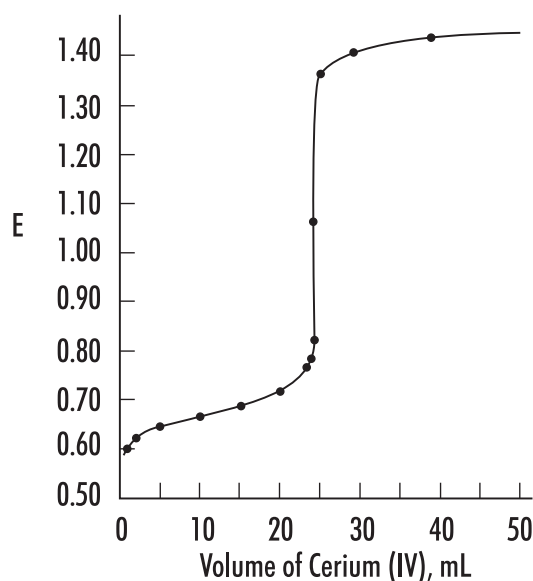

Figure 8

Visual indicators such as Ferroin are also available. The oxidized and reduced form of the indicator will have different colors and can be used to determine the endpoint.

Various reductants can be determined by titrants with oxidants such as potassium permanganate, potassium chromate or iodine. Commonly used reductants that are used as titrants include sodium thiosulfate and ferrous ammonium sulfate. As with acid-base titrations the potential changes dramatically at the equivalence point.

2.3. TITRATIONS ACCORDING TO THE TITRATION SEQUENCE

2.3.1. BACK TITRATIONS

Back titrations are generally used when a reaction is too slow to be directly accomplished during a “direct” titration, where the reaction goes to completion within a few seconds. In a back titration, a large excess of a reagent is added to the sample solution, helping a slow reaction to go to completion. The unreacted, excess reagent is then titrated. The difference in the total volume of the first reagent added and amount determined from the second titration is the quantity of reagent required to complete the first reaction.

2.3.2. MULTIPLE ENDPOINT TITRATIONS

Under certain conditions, some titrations can exhibit more than one equivalence point and be titratable to the individual endpoints to determine the concentration of each individual component. Examples of these types of titrations include acid-base, where different strength acid or bases are in a mixture; redox, where each species has a different reduction potential; complexometric, where different species are separately titratable; and acid-base, using polyprotic acids (the pK_a of the different protons varies enough to separate them).

Figure 9 shows three different types of multiple endpoint titrations. Graph **A** shows the titration of a polyprotic acid. The different acid strengths of the first and second proton can be determined. Graph **B** illustrates a mixture of two different metal redox species, where the different redox potentials allow the species to be separated. Graph **C** is the titration of a solution containing strong, weak and very weak acids.

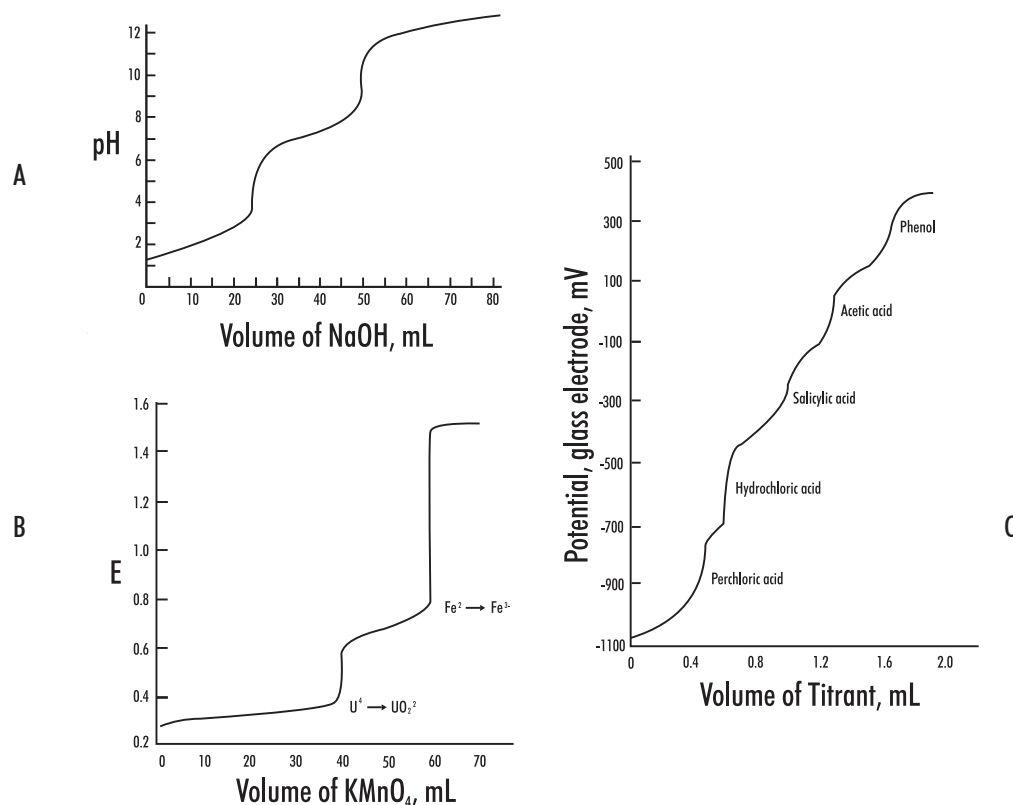

Figure 9

3. TITRATION PROCEDURE

3.1. MANUAL TITRATION

Apparatus required for manual titration include:

- Volumetric burette, for precisely controlled delivery of titrant to the reaction vessel
- Erlenmeyer, or similar flask, that facilitates constant mixing or swirling required to ensure solution homogeneity
- Volumetric pipettes for the precise addition of samples and indicator solutions
- Titrant solutions of known concentration
- A visual or instrumental indicator for detecting the completion of the reaction

A typical manual titration consists of the following steps:

- 1) A volumetric pipette is typically used to add a known volume of sample to the flask.
- 2) An indicator solution or instrument probe is added to the flask.
- 3) A burette is used to measure the addition of titrant to the flask and dispense titrant in a controlled manner.
- 4) Titrant is added via the burette until the method indication signals the reaction endpoint.
- 5) The concentration of analyte is calculated based on the concentration and volume of titrant required to reach the endpoint.

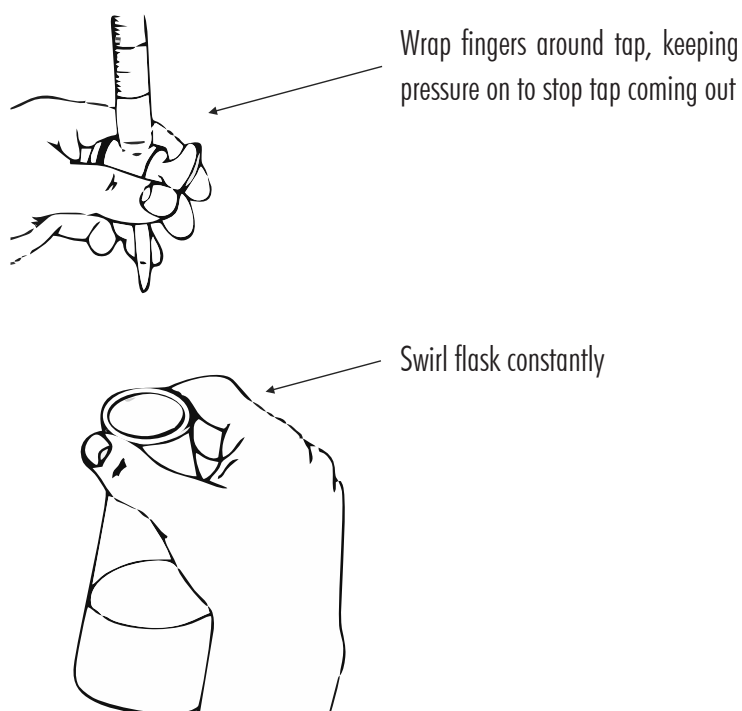

3.2. AUTOMATIC TITRATION

Automatic titrators are high-precision analytical instruments that deliver the titrant, monitor the physical change associated with the titration reaction, automatically stops at the endpoint and calculates the concentration of the analyte. Automatic titrators are best for repetitive titrations and high-accuracy analyses.

An automatic titrator must have an accurate liquid dispensing system. In high accuracy systems like the **HI900**-series titrators, the liquid dispensing system consists of a stepper-motor driven piston syringe burette capable of accurately and precisely dispensing very small volumes of titrant, a valve system to switch between titrant intake and outlet, and a dispensing tip. These three main subsystem components must be as accurate as possible, with very low gear backlash in the burette pump, minimal piston seal flexing, precision ground inner diameter of the glass syringe, a low dead volume valve, minimal evaporation/permeation, and chemically resistant tubing.

Apparatus required for automatic titration include:

- An automatic titrator, equipped with a burette
- A beaker
- An electronic stirring system, either a propeller stirrer or a magnetic stir bar and stir plate
- Volumetric pipettes for the precise addition of samples
- Standard titrant solutions of known concentration
- An electrode system that can be used to determine the endpoint of the titration

A typical automatic titration consists of the following steps:

- 1) Set up the automatic titrator according to the manufacturer's instructions.
- 2) A volumetric pipette is typically used to add a known volume of sample to the beaker.
- 3) Submerge the propeller stirrer or add the stir bar to the beaker and turn on.
- 4) Start the titration, the titrator will automatically stop at the endpoint and determine the concentration of the analyte.

4. TITRATION RESULTS

4.1. ACCURACY

The factors most critical to achieving accurate results with the **HI900** titration systems are the concentration of the sample, size of the sample and having an optimized set of method parameters.

4.2. REPEATABILITY

Repeatability, or the agreement between replicate determinations, is expressed quantitatively as the relative standard deviation (RSD).

4.3. SOURCES OF ERROR

One of the advantages of volumetric analysis is excellent accuracy and precision. The sources of error can be grouped into sampling, titrant and standards, chemical reactions, endpoint determination and calculations.

4.3.1. SAMPLING ERRORS

- Selection of a non-homogeneous or non-representative sample
- Sample changed or was contaminated during collection, storage or transfer
- Poor technique when transferring sample to beaker or flask
- Errors in the balance (calibrate and check balance regularly)

4.3.2. PREPARATION ERRORS

Incorrect preparation due to:

- Poor technique in weighing the salt or when transferring to volumetric glassware
- Low-purity of salts or water used to make titrant and standard
- Dirty or wet glassware
- Improper storage of titrant or standard which allows water gain, evaporation or deterioration
- Failure to standardize frequently to adjust for change in titrant
- Failure to flush titrator tubing with a volume of titrant before standardizing
- Volume errors from pipettes and volumetric flasks (grade A glassware is required)
- Balance errors when weighing out salts (calibrate and check balance regularly)

4.3.3. DISPENSING ERRORS

Incorrect dispensing due to:

- Dead valve volume and leaking valve
- Inaccuracy in motor drive and gear lash/backlash
- Poor burette/piston seal
- Non-uniform diameter of burette glass cylinder
- Chemical incompatibility with tubing or bubble generation
- Density/temperature changes in titrant
- Inadequate volume to cover electrode

4.3.4. CHEMICAL REACTION ERRORS

- Inappropriate solvent or sample, resulting in side reactions
- Poor mixing of the titrant and solvent or sample in the titration vessel
- Reaction between titrant and sample is not rapid
- Reaction does not go to completion
- Reaction has side reactions

4.3.5. ENDPOINT DETERMINATION ERRORS

Most manual titrations use a visual indicator to indicate when the endpoint is reached and the titration should be stopped. Automatic titrators use instrumental methods to determine the end of a titration and the equivalence point. There are two predominant methods used to determine the equivalence point, first derivative and second derivative.

The inflection point of the titration curve (mV vs. volume) is normally assumed to be the equivalence point. The first derivative is often used to determine the inflection point. The maximum value of the first derivative (ΔmV vs. ΔV) corresponds to the theoretical equivalence point. During a titration it is rare to have a data point exactly at the first derivative maximum, the maximum value is determined by interpolating the first derivative data points.

The second derivative (ΔmV^2 vs. ΔV^2) can also be used to determine the equivalence point, and can offer advantages over the first derivative method. Second derivatives have increased sensitivity to smaller inflection points and easier numerical evaluation of the actual equivalence point. The value where the second derivative is equal to zero is the equivalence point. The second derivative requires fewer points located near the equivalence point, where data is often not obtained or not as reliable.

Errors in determining the endpoint can result from:

- Incorrect signals from the sensor
- Sensor drift
- Sensor or instrument has slow response (it is recommended to keep the sensors in good condition)
- Inappropriate setting on the titrator

5. CALCULATIONS

5.1. EQUATIONS USED IN VOLUMETRIC KARL FISCHER TITRATIONS

5.1.1. CALCULATION OF WATER CONTENT AS % MASS FROM SAMPLES MEASURED BY MASS

$$C_{\text{sample}} = \frac{V_{\text{titrant}} \times \text{Titer}}{m_{\text{sample}} \times (1000 \text{ mg/g})} \times 100$$

C_{sample} Concentration of Sample (% w/w)

V_{titrant} Volume of Titrant (mL)

Titer Titrant Titer (mg/mL)

m_{sample} Mass of Sample (g)

5.1.2. CALCULATION OF WATER CONTENT AS % MASS FROM SAMPLES MEASURED BY VOLUME

$$C_{\text{sample}} = \frac{V_{\text{titrant}} \times \text{Titer}}{V_{\text{sample}} \times d_{\text{sample}} \times (1000 \text{ mg/g})} \times 100$$

C_{sample} Concentration of Sample (% w/w)

V_{titrant} Volume of Titrant (mL)

Titer Titrant Titer (mg/mL)

V_{sample} Volume of Sample (mL)

d_{sample} Density of Sample (g/mL)

5.1.3. CALCULATION OF WATER CONTENT AS % VOLUME FROM SAMPLES MEASURED BY VOLUME

$$C_{\text{sample}} = \frac{V_{\text{titrant}} \times \text{Titer}}{V_{\text{sample}} \times d_{\text{water}} \times (1000 \text{ mg/g})} \times 100$$

C_{sample} Concentration of Sample (% w/w)

V_{titrant} Volume of Titrant (mL)

Titer Titrant Titer (mg/mL)

V_{sample} Volume of Sample (mL)

d_{water} Density of Water at Analysis Temperature (g/mL)

5.1.4. CALCULATION OF WATER CONTENT AS % MASS SUBTRACTING BACKGROUND DRIFT RATE

$$C_{\text{sample}} = \frac{(V_{\text{titrant}} \times \text{Titer}) - [\text{Drift} \times t \times (1 \text{ mg}/1000 \text{ } \mu\text{g})]}{m_{\text{sample}} \times (1000 \text{ mg/g})} \times 100$$

C_{sample} Concentration of Sample (% w/w)

V_{titrant} Volume of Titrant (mL)

Titer Titrant Titer (mg/mL)

Drift Background Drift Rate ($\mu\text{g}/\text{min}$)

t Titration Duration (min)

m_{sample} Mass of Sample (g)

5.1.5. CALCULATION OF WATER CONTENT IN EXTERNAL DISSOLUTION SAMPLES

$$C_{\text{sample}} = \left[\frac{m_{\text{solvent}} \times (C_{\text{solution}} - C_{\text{solvent}})}{m_{\text{sample}}} + C_{\text{solution}} \right] \times 100$$

C_{sample}	Concentration of Sample (% w/w)
m_{solvent}	Mass of Solvent (g)
C_{solution}	Water Content of Dissolved Sample (w/w)
C_{solvent}	Water Content of Solvent (w/w)
m_{sample}	Mass of Sample (g)

5.1.6. CALCULATION OF WATER CONTENT IN EXTERNAL EXTRACTION SAMPLES

$$C_{\text{sample}} = \frac{m_{\text{titrant}} \times (C_{\text{supernatant}} - C_{\text{solvent}})}{m_{\text{solvent}} \times (1 - C_{\text{supernatant}})} \times 100$$

C_{sample}	Concentration of Sample (% w/w)
m_{solvent}	Mass of Solvent (g)
$C_{\text{supernatant}}$	Water Content of Dissolved Sample (w/w)
C_{solvent}	Water Content of Solvent (w/w)
m_{sample}	Mass of Sample (g)

5.1.7. CALCULATION OF WATER CONTENT IN GASEOUS SAMPLES

The water content of gases is normally reported in units of $\mu\text{g/L}$ or mg/L .

$$C_{\text{sample}} = \frac{V_{\text{titrant}} \times \text{Titer}}{\text{Flow Rate} \times \text{Flow Duration}}$$

C_{sample}	Concentration of Sample (mg/mL)
V_{titrant}	Volume of Titrant (mL)
Titer	Titrant Titer (mg/mL)
Flow Rate	Sample Flow Rate (L/min)
Flow Duration	Sample Extraction Time (min)

To calculate the water content in %w/w the mass of the gas introduced into the titration vessel must be known. This can be determined by calculations using ideal gas laws or by measuring the mass of the sample container before and after a titration.

5.1.8. CALCULATION OF TITER (WATER EQUIVALENT OF THE TITRANT) USING SODIUM TARTRATE DIHYDRATE CONTAINING 15.66% WATER BY MASS

$$C_{\text{titrant}} = \frac{m_{\text{sample}} \times C_{\text{tartrate}}}{V_{\text{titrant}}}$$

C_{titrant}	Titrant Titer (mg/mL)
m_{sample}	Mass of Sample (g)
C_{tartrate}	Water Content of Tartrate (156.6 mg/g)
V_{titrant}	Volume of Titrant (mL)

5.1.9. CALCULATION OF TITER (WATER EQUIVALENT OF THE TITRANT) USING WATER STANDARDS

$$C_{\text{titrant}} = \frac{m_{\text{sample}} \times C_{\text{standard}}}{V_{\text{titrant}}}$$

C_{titrant}	Titration Titer (mg/mL)
m_{sample}	Mass of Sample (g)
C_{standard}	Water Content of Standard (mg/g)
V_{titrant}	Volume of Titrant (mL)

5.2. EQUATIONS USED IN TITRATIONS

The main variables used in calculating a result from a titration are the sample volume, the concentration of the titrant, and the volume of titrant required to reach the equivalence point. At the equivalence point, an equal number of equivalents of the analyte and titrant has been added.

5.2.1. SAMPLE CALCULATION BY MASS

$$C_{\text{sample}} = \frac{V_{\text{titrant}} \times C_{\text{titrant}} \times \text{Ratio} \times \text{FW}_{\text{analyte}}}{m_{\text{sample}}} \times 100$$

C_{sample}	Sample Concentration (g/100g)
V_{titrant}	Volume of titrant
C_{titrant}	Titration Concentration (eq/L)
Ratio	Equivalence ratio of analyte/ titrant (mol analyte/ eq titrant)
$\text{FW}_{\text{analyte}}$	Formula Weight of the Analyte (g/mol)
m_{sample}	Mass of Sample (g)

5.2.2. SAMPLE CALCULATION BY VOLUME

$$C_{\text{sample}} = \frac{V_{\text{titrant}} \times C_{\text{titrant}} \times \text{Ratio} \times \text{FW}_{\text{analyte}}}{V_{\text{sample}}} \times 100$$

C_{sample}	Sample Concentration (g/100g)
V_{titrant}	Volume of titrant
C_{titrant}	Titration Concentration (eq/L)
Ratio	Equivalence ratio of analyte/ titrant (mol analyte/ eq titrant)
$\text{FW}_{\text{analyte}}$	Formula Weight of the Analyte (g/mol)
V_{sample}	Volume of Sample (mL)

5.2.3. STANDARDIZE TITRANT BY MASS

Titrant standardization is the second most important calculation in titrations. A primary standard is titrated in order to determine the concentration of the titrant. This is essentially a typical titration calculated in “reverse”, where the concentration of the solution is known and the titrant is unknown.

$$C_{\text{titrant}} = \frac{m_{\text{standard}} \times \text{Ratio}}{FW_{\text{standard}} \times V_{\text{titrant}}}$$

C_{titrant}	Titrant Concentration (N)
m_{standard}	Mass of Standard (g)
Ratio	Equivalence ratio of titrant/standard (eq titrant/ mol standard)
FW_{standard}	Formula Weight of the Standard (g/mol)
V_{titrant}	Volume of Titrant (L)

5.2.4. STANDARDIZE TITRANT BY VOLUME

$$C_{\text{titrant}} = \frac{V_{\text{standard}} \times (1 \text{ L}/1000 \text{ mL}) \times C_{\text{standard}}}{V_{\text{titrant}}}$$

C_{titrant}	Titrant Concentration (N)
V_{standard}	Volume of Standard (mL)
C_{standard}	Concentration of Standard (eq/L)
V_{titrant}	Volume of Titrant (L)

5.2.5. BLANK TITRATION

In a blank titration a pre-titration is performed, often times on the solvent to be used for the sample titration, and the titrant volume required to reach the endpoint is noted. This blank value nullifies error due to titrant required to react with the components of the titration solution matrix. The basic titration equation can be used for a blank titration, with the single modification that the volume of titrant used in the blank titration should be subtracted from the regular titration titrant volume.

$$C_{\text{sample}} = \frac{C_{\text{titrant}} \times (V_{\text{sample}} - V_{\text{blank}}) \times \text{Ratio} \times FW_{\text{analyte}}}{m_{\text{sample}}} \times 100$$

C_{sample}	Sample Concentration (g/100 g)
C_{titrant}	Titrant Concentration (eq/L)
V_{sample}	Volume of Titrant required for the sample (L)
V_{blank}	Volume of Titrant required for the blank (L)
Ratio	Equivalence ratio of analyte/ titrant (mol analyte/ eq titrant)
FW_{analyte}	Formula Weight of the Analyte (g/mol)
m_{sample}	Mass of Sample (g)

5.2.6. MULTIPLE ENDPOINT TITRATION

Some titrations have two or more endpoints, each corresponding to the equivalence point for a specific reaction. Multiple endpoint titrations are similar to a blank titration in that the volume of titrant required to reach the first endpoint is subtracted from the titrant volume used to reach the next sequential endpoint.

$$C_{\text{sample1}} = \frac{V_{\text{titrant1}} \times C_{\text{titrant}} \times \text{Ratio} \times \text{FW}_{\text{analyte1}}}{m_{\text{sample}}} \times 100$$

$$C_{\text{sample2}} = \frac{(V_{\text{titrant2}} - V_{\text{titrant1}}) \times C_{\text{titrant}} \times \text{Ratio} \times \text{FW}_{\text{analyte2}}}{m_{\text{sample}}} \times 100$$

$$C_{\text{sample3}} = \frac{(V_{\text{titrant3}} - V_{\text{titrant2}}) \times C_{\text{titrant}} \times \text{Ratio} \times \text{FW}_{\text{analyte3}}}{m_{\text{sample}}} \times 100$$

C_{sample1}	Sample 1 Concentration (g/100g)
C_{sample2}	Sample 2 Concentration (g/100g)
C_{sample3}	Sample 3 Concentration (g/100g)
V_{titrant1}	Volume of titrant required to reach the first endpoint (L)
V_{titrant2}	Volume of titrant required to reach the second endpoint (L)
V_{titrant3}	Volume of titrant required to reach the third endpoint (L)
C_{titrant}	Concentration of titrant (N)
Ratio	Equivalence ratio of analyte/titrant (mol analyte/eq titrant)
$\text{FW}_{\text{analyte1}}$	Formula Weight of the Analyte 1 (g/mol)
$\text{FW}_{\text{analyte2}}$	Formula Weight of the Analyte 2 (g/mol)
$\text{FW}_{\text{analyte3}}$	Formula Weight of the Analyte 3 (g/mol)
m_{sample}	Mass of Sample (g)

5.2.7. BACK TITRATION

The equation used in back titration calculations is also similar to the equation for a blank titration. Instead of subtracting the initial amount of titrant needed to react with the blank, the amount of second titrant needed to react with the excess titrant added in the first titration is subtracted from the amount of the first titrant added. The difference between the two amounts is the amount of titrant necessary to reach the first equivalence point.

$$C_{\text{sample}} = \frac{(C_{\text{titrant1}} \times V_{\text{titrant1}} - C_{\text{titrant2}} \times V_{\text{titrant2}}) \times \text{Ratio} \times \text{FW}_{\text{analyte}}}{V_{\text{sample}}} \times 100$$

C_{sample}	Sample Concentration (g/100mL)
C_{titrant1}	Concentration of titrant 1 (N)
V_{titrant1}	Volume of titrant 1 (L)
C_{titrant2}	Concentration of titrant 2 (N)
V_{titrant2}	Volume of titrant 2 (L)
Ratio	Equivalence ratio of analyte/titrant (mol analyte/ eq titrant)
$\text{FW}_{\text{analyte}}$	Formula Weight of the analyte (g/mol)
V_{sample}	Volume of sample (mL)

6. GLOSSARY

Acid

A chemical species that can donate one or more protons (hydrogen ions).

Acid-Base Titration

Stoichiometric neutralization titrations, based upon the reaction that occurs between an acid and base.

Activity

A physical property corresponding to the concentration of all ions in a solution. Electrodes respond to activity.

Amperometric Titration

Titrations where the current flow between two electrodes (often a metal electrode and a reference electrode) are used to monitor the titration progress.

Analyte

The chemical species being measured in a titration.

Argentometric Titration

Titrations that use silver (nitrate) as the titrant. These titrations are typically precipitation titrations.

Automatic Titrator

An instrument designed to automatically carry out a titration. It will add the appropriate amount of titrant, determine the endpoint and calculate the results.

Back Titration

A type of titration where an excess amount of titrant is added to a sample forcing a sluggish reaction to go to completion. The excess reagent is then "back" titrated with a second titrant.

Base

A chemical species that can accept one or more protons (hydrogen ions).

Biamperometric Indication

Uses a double platinum pin electrode to measure the current flow through a titration solution.

Bivoltametric Indication

Uses a double platinum pin electrode to measure the voltage required to maintain a constant current flow through a titration solution while constant voltage is applied across the platinum elements of the electrode.

Burette

A graduated cylindrical piece of laboratory glassware that is used to dispense precise amounts of solution.

Complex Ion

A species where a central metal ion is covalently bonded to one or more electron donating groups called ligands.

Complexometric Titrations

Metal ions are titrated using a titrant that binds strongly to it. The titrants often contain Ethylenediaminetetraacetic Acid (EDTA) or Cyclohexylenedinitrilotetraacetic Acid (CDTA).

End point

The point where a titration is stopped because a physical change in the solution has indicated a completed titration. Titration endpoints typically coincide with the equivalence point. A fixed value endpoint (pH or mV) can be used as well, the titration will stop at the desired point regardless of whether or not is complete.

Equivalence point

The point where the quantity of titrant is stoichiometrically equal to the quantity of analyte.

Formal

The theoretical number of equivalents per liter of the solution. It is used in solutions where the exact concentration of a species may be affected by the other ions present, therefore the stated concentration may not be exactly correct.

Gravimetric Analysis

A quantitative determination of an analyte based on the mass of the solid.

Indicator Electrode

An electrode that responds to the species of interest. The electrode potential is proportional to the concentration or activity of that ion in the solution being measured.

Indicators

Chemical indicators are typically organic dyes that change form under different physical conditions, causing a color change that can be seen by an analyst. Typically used in manual titrations. Chemical indicators have been replaced with electrometric indicators, which are used with automatic titrators.

Inflection Point

The point on a titration curve where the second derivative curve changes signs.

Ion Selective Electrode (ISE)

An electrode that responds to a specific ion, the electrode potential is proportional to the concentration or activity of that ion in the solution being measured.

Karl Fischer Titration

A titration that uses a chemical reaction that is specific for determining water.

Manual Titration

A titration that is carried out by hand, the analyst must add the appropriate amount of titrant, determine the endpoint and calculate the results.

Molar

The concentration of a solute in a solution.

Mole (mol)

A quantity of a chemical species. The molecular weight of a substance in grams is equal to the mass of one mole of the substance. One mole is equal to 6.022×10^{23} atoms or molecules.

Monochromator

A device that allows only a narrow range of wavelengths to pass through it by separating the light into different wavelengths.

Multiple End point Titration

A titration that reacts multiple species in solution, sequentially using the same titrant. The concentration of each analyte can be determined from their respective endpoints.

Nernst Equation

The fundamental equation relating cell voltage to the concentration of a solution.

Neutralization

A chemical reaction where an acid and a base react to form a neutral salt and water.

Non-aqueous

A solution that does not contain water.

Non-aqueous Titration

A titration that is performed in non-aqueous solutions. Typically used to titrate very weak acid and bases to eliminate the leveling effect water has on all acids and bases dissolved in it.

Normal

The concentration of a solution which accounts for any stoichiometric difference between the various species in a solution.

Oxidation/ Reduction Potential (ORP)

A voltage generated in a solution which is a result of the ratio of the oxidized to reduce species. Typically measured potentiometrically with an ORP sensor.

Oxidant

The species that is accepting electrons in a redox reaction.

Pipette

Scientific apparatus that is used to deliver precise volumes of liquids.

Polyprotic Acid

Acids that are capable of donating more than one proton per acid molecule.

Potentiometric Titration

A titration in which the endpoint is determined by monitoring the voltage of the solution using an electrode.

Precipitation Titration

A titration in which the analyte reacts with the titrant to form an insoluble compound. The endpoint is typically detected with an ISE sensitive to either the analyte or titrant.

Reagent

The chemical added in a titration that causes the given reaction to occur.

Reduction-Oxidation Reaction (redox)

A chemical reaction in which the atoms involved in the reaction have their oxidation numbers changed. Reduction is the gain of electrons, which decreases the oxidation number. Oxidation is the loss of electrons, which increases the oxidation number.

Reductants

The electron donor in a redox reaction.

Reference Electrode

An electrode that supplies a constant electrode potential. It is used in combination with an "indicator" electrode, allowing for the "indicator" electrode potential to be measured.

Relative Standard Deviation (RSD)

A measure of the amount of relative variation in a set of data. It is calculated by dividing the standard deviation by the mean:

$$\text{RSD} = (\text{Standard Deviation of } X) * 100 / (\text{Mean of } X)$$

Repeatability

The variation in sample measurements taken by a single person or instrument under the same conditions.

Spectrophotometric Titration

A titration in which the endpoint is marked by a change in the color and/or color intensity.

Stoichiometry

The quantitative relationship of the reactants and products in a chemical reaction.

Titrant

The chemical added in a titration that causes the given reaction to occur.

Titration

A quantitative, volumetric procedure used in analytical chemistry to determine the concentration of an analyte in solution. The concentration of the analyte is determined by slowly adding a titrant to the solution. As the titrant is added, a chemical reaction between the titrant and the analyte occurs.

Titration Curve

A graph containing the physical data obtained for a titration. The data plotted is often an independent variable (volume of titrant) vs. a dependent variable (pH of the solution). From the titration curve, the equivalence point or endpoint can be determined.

Certification

All Hanna Instruments conform to the **CE European Directives**.



RoHS
compliant

Disposal of Electrical & Electronic Equipment. The product should not be treated as household waste. Instead hand it over to the appropriate collection point for the recycling of electrical and electronic equipment which will conserve natural resources.

Ensuring proper product and battery disposal prevents potential negative consequences for the environment and human health. For more information, contact your city, your local household waste disposal service, the place of purchase or go to www.hannainst.com.



Recommendations for Users

Before using this product, make sure it is entirely suitable for your specific application and for the environment in which it is used. Any variation introduced by the user to the supplied equipment may degrade the meters' performance. For yours and the meter's safety do not use or store the meter in hazardous environments.

Warranty

The **HI934** is warranted for two years against defects in workmanship and materials when used for its intended purpose and maintained according to instructions. Damage due to accidents, misuse, tampering or lack of prescribed maintenance is not covered.

If service is required, contact your local Hanna Instruments Office. If under warranty, report the model number, date of purchase, serial number and the nature of the problem. If the repair is not covered by the warranty, you will be notified of the charges incurred. If the instrument is to be returned to Hanna Instruments, first obtain a Returned Goods Authorization (RGA) number from the Technical Service department and then send it with shipping costs prepaid. When shipping any instrument, make sure it is properly packed for complete protection.

Hanna Instruments reserves the right to modify the design, construction or appearance of its products without advance notice.

World Headquarters

Hanna Instruments Inc.
584 Park East Drive
Woonsocket, RI 02895 USA
www.hannainst.com